



JBZ-OC100



Intelligence Model

Paper Cup Machine

100-120 PCS-MIN



Single Plate High Speed



MINGYUAN

Ruian Mingyuan Machinery Co., Ltd

CATALOGUE”

Catalogue Of Product Album

03

PART1

Parameters

06

PART2

Selling Points

19

PART3

Electric List

21

PART4

Free Spare Parts

23

PART5

After-sales

25

PART6

Certificates

26

PART7

Company Image

27

PART8

Other Machine



Click to jump to pages



MINGYUAN

Ruian Mingyuan Machinery Co., Ltd

Parameters

03

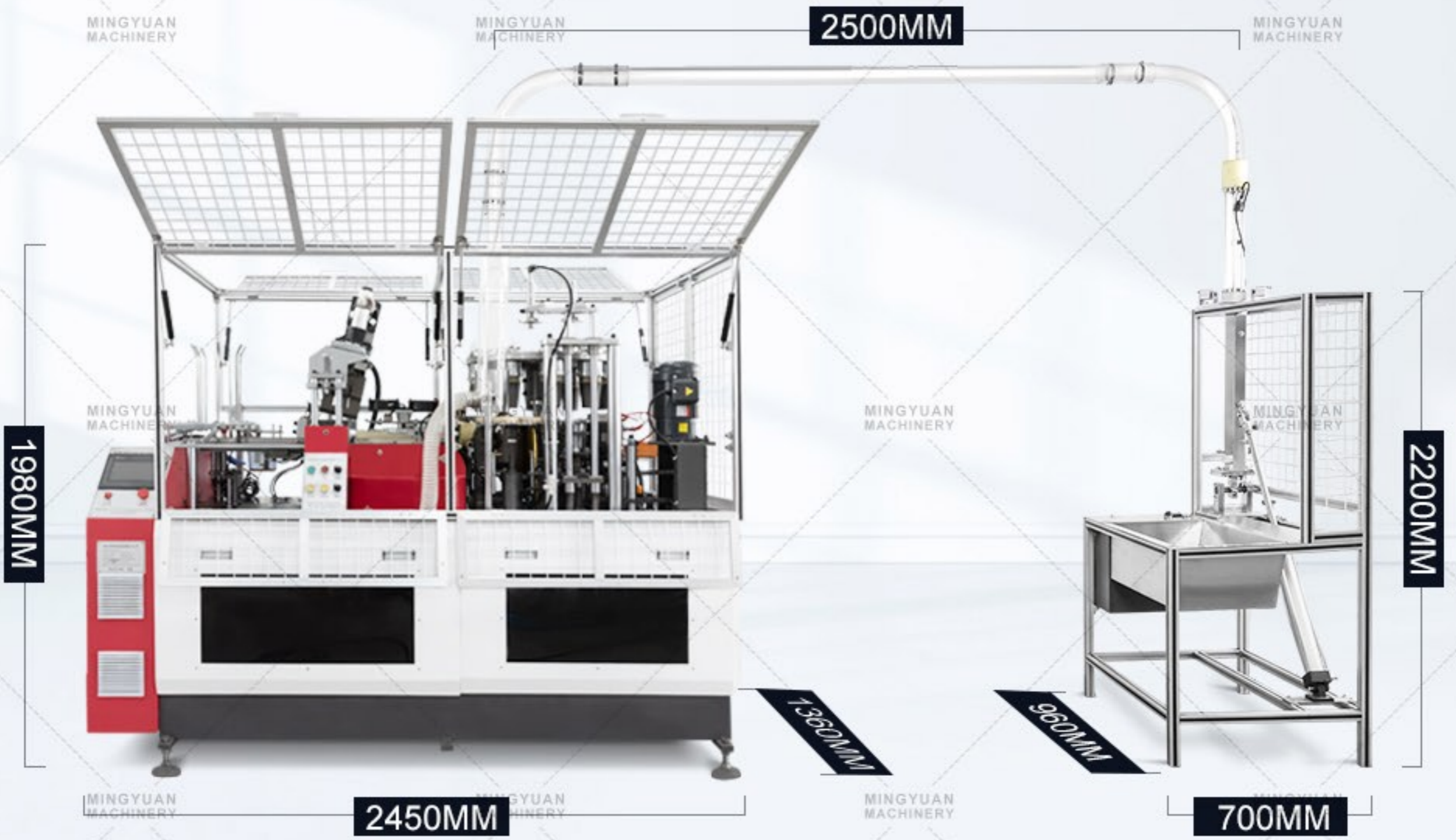

| | |
|-----------------------|---|
| Model | High Speed Intelligence Model Ultrasonic Paper Cup Machine JBZ-OC100 |
| Cup Side Welding | Ultrasonic heater |
| Paper Cup Size | 2 ~12 OZ (Mould exchangeable, Max Cup Height:115mm , Max Bottom width :76mm |
| Rated Speed | 95-105pcs/min (Speed affected by cup size, paper quality & thickness) 9OZ, 280GSM paper cup Stable running speed 100 pcs each min. |
| Raw Material | One or Two side PE coated Paper(Popular for Hot and Cold drink Cups) |
| Suitable paper weight | 140-350gsm |
| Power Source: | 50/60HZ, 380V/220V (better use 380V, 3 Phase) or special Power requirement. |
| Total Power | 5KW |
| Total Weight | GW/NW: 1800KGS/1750KGS |
| Pack Size (L*W*H) | 2450*1360*1980mm(machine size) 960*700*2200mm(collecting table size) |
| Working Air Source | Air pressure:0.4Mpa; Air Out-put:0.6m ³ /minute Need to buy Air Compressor(by user) |
| Cup Side Welding | Heater Knurling |
| Cup Bottom Heating | 1side PE paper by heater knurling; 2side PE paper by cool device (circle water) knurling. |
| Cup Bottom Knurling | Heater Knurling (if use single PE coated paper) |

OEM (Show Client Company Name in Machine Panel) is welcome in our factory



Click To View Machine Video

Ruian Mingyuan Machinery Co., Ltd

Cup Size Range

04

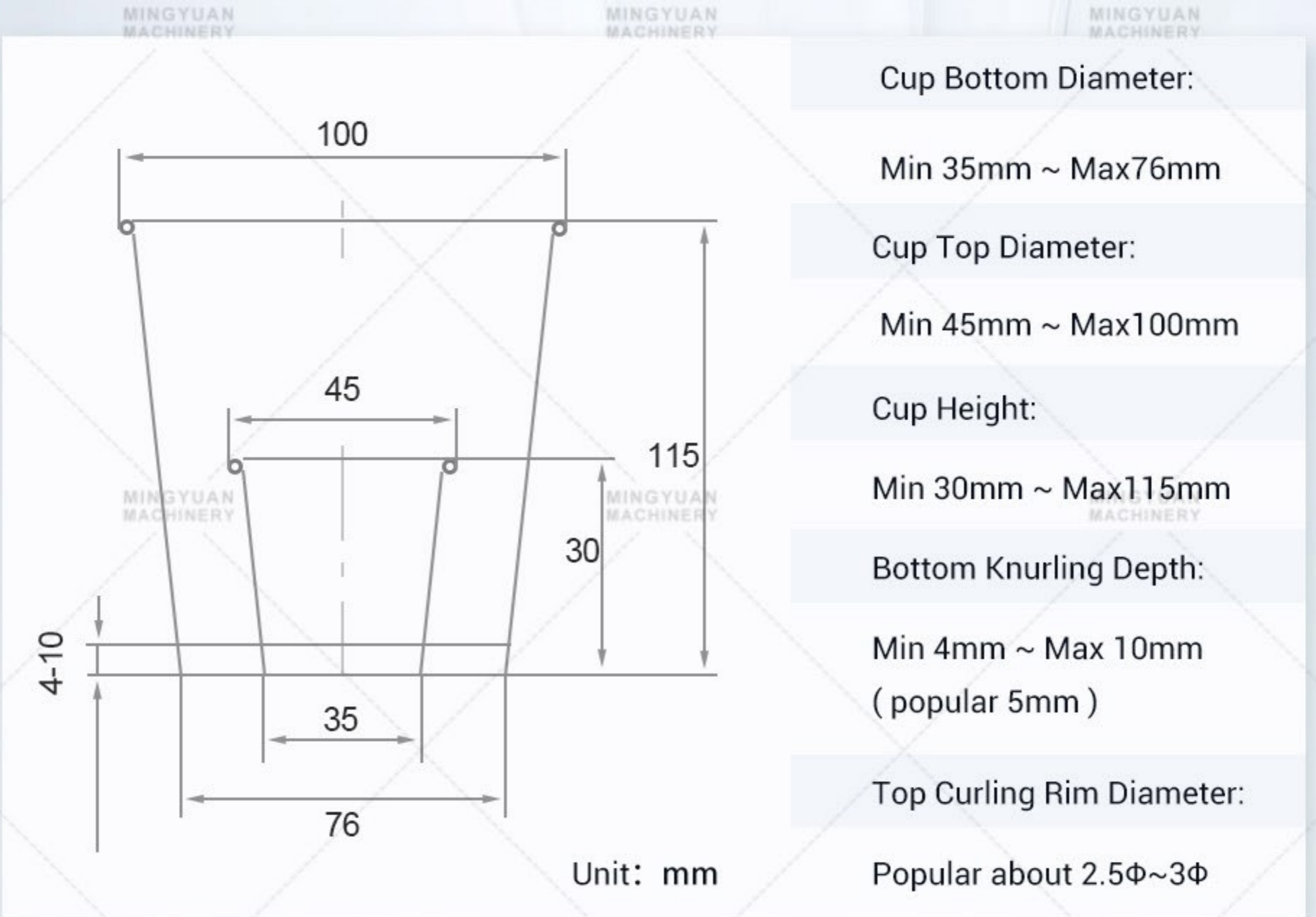

Ruian Mingyuan Machinery Co., Ltd



Different Size Cups with different bottom diameter and angle, (Difficult to change mould). We NO Suggestion Client to change Full Set Mould which easy be trouble of machine. For One Set machine is better goes with 1-2 extra half sets mould



Different Size Cups with same bottom diameter and angle, Just different size in cup height and Top Dia.

Selling Points

06

Electric System

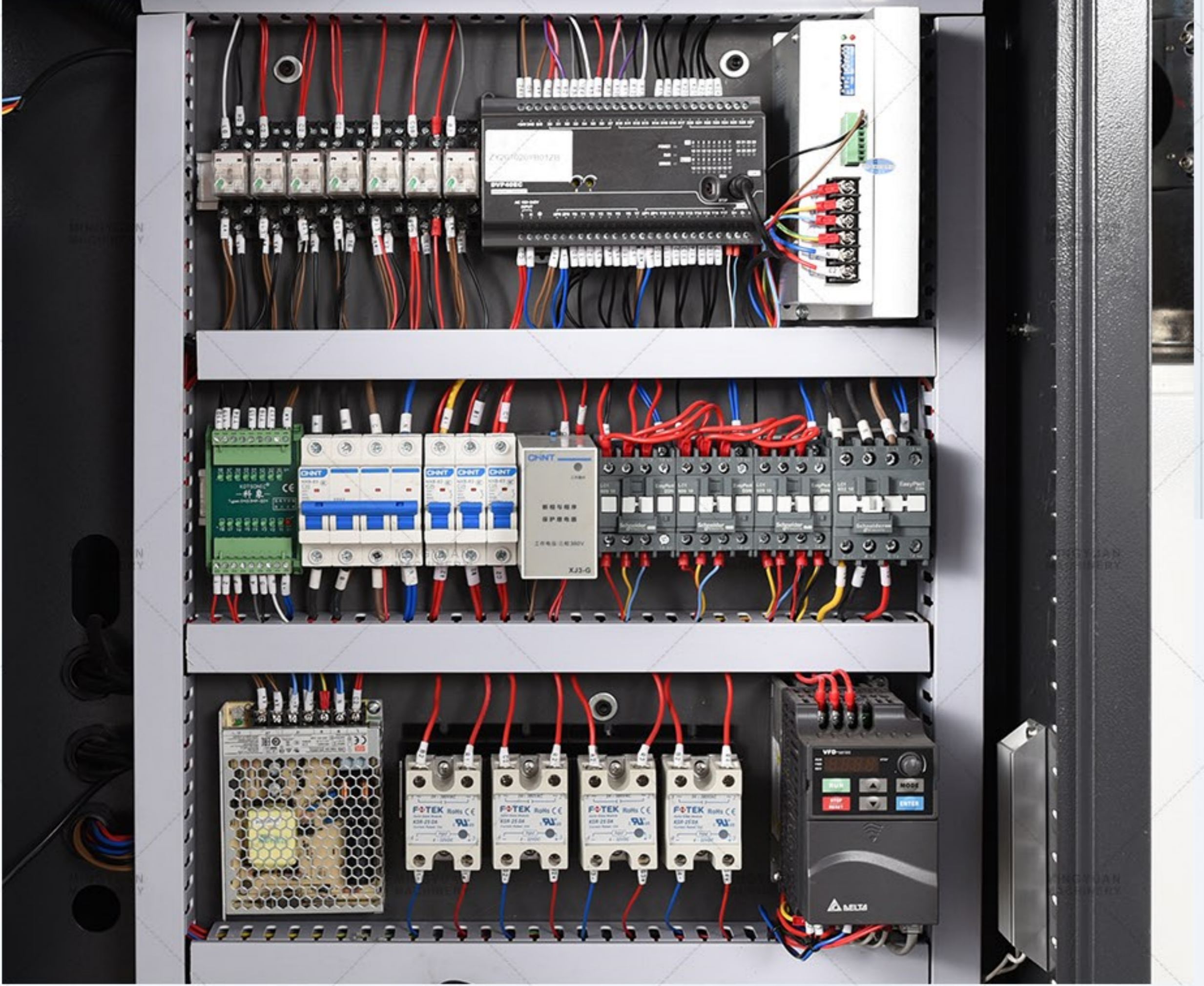

Delta PLC Controller



DELTA Inverter

Quality Brand electric System like Delta, Schneider.

Ruian Mingyuan Machinery Co., Ltd

1-Paper Fan Less Sensor

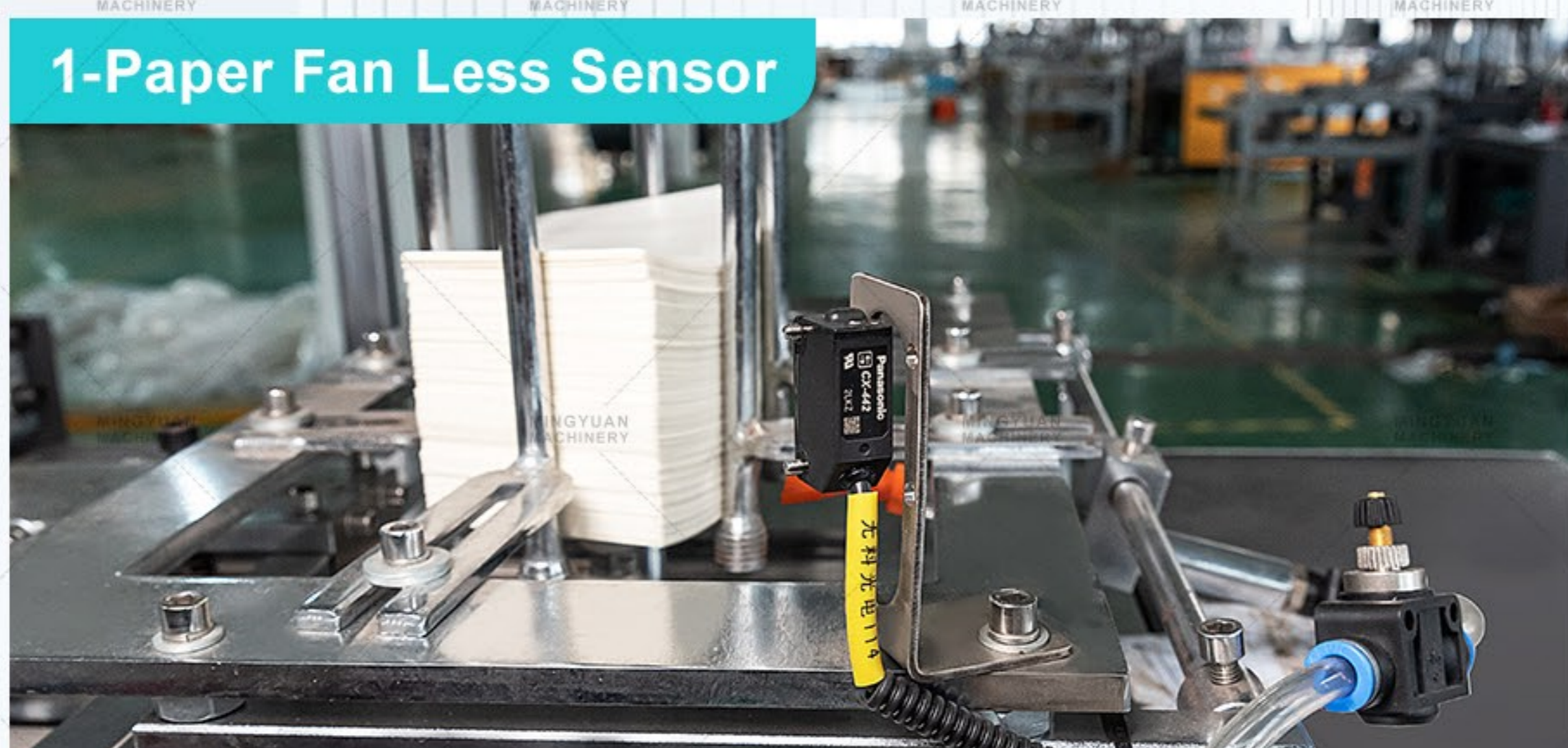

If Less paper ,the sensor will send alarm and show errors information in touch screen

2-Paper Fan Sealing Sensor



If the sensor detects the paper fan , it will send the ultrasonic welding signal to seal the paper side

3-Cup Body Blocking Sensor

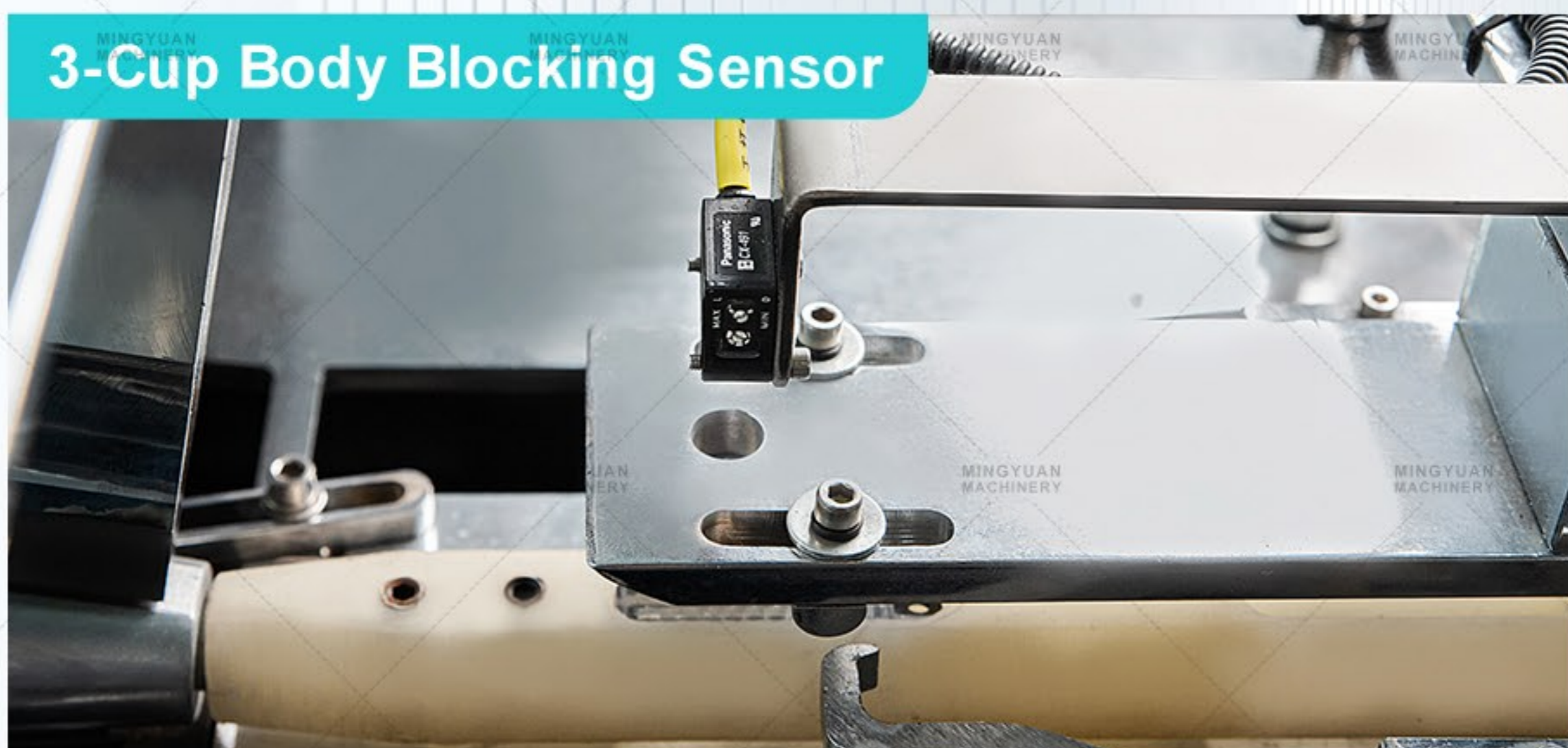

If the paper body get blocked or stuck in paper tube feeding,the sensor will send alarm and show errors information in touch screen

4-Cup Pass By Sensor

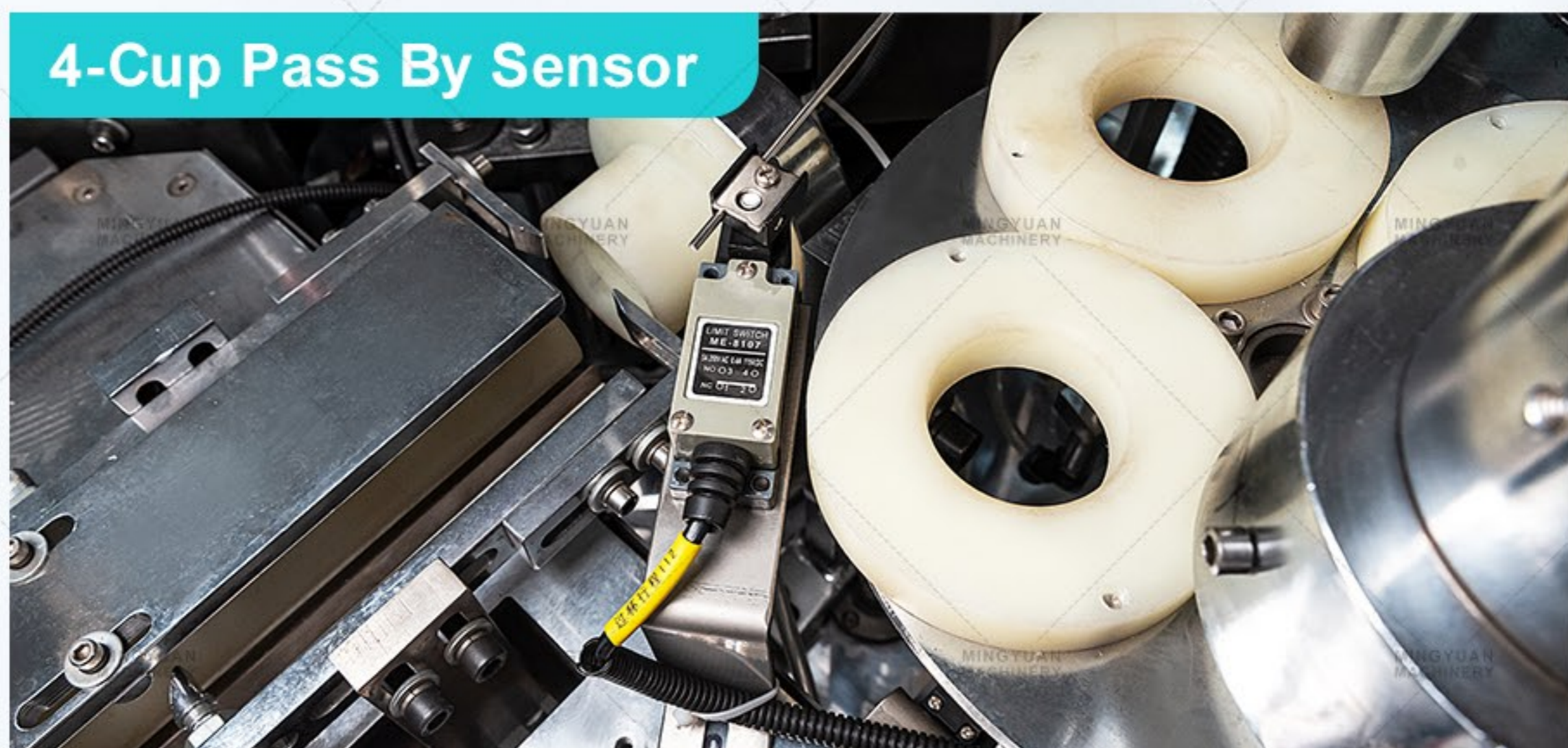

If the sensor detects that finished cup is not be discharged, it will send the alarm information

5-Cup Dropping Off Sensor



If the cups drop off from the mould , it will send the alarm

6-Bottom Paper Feeding Sensor

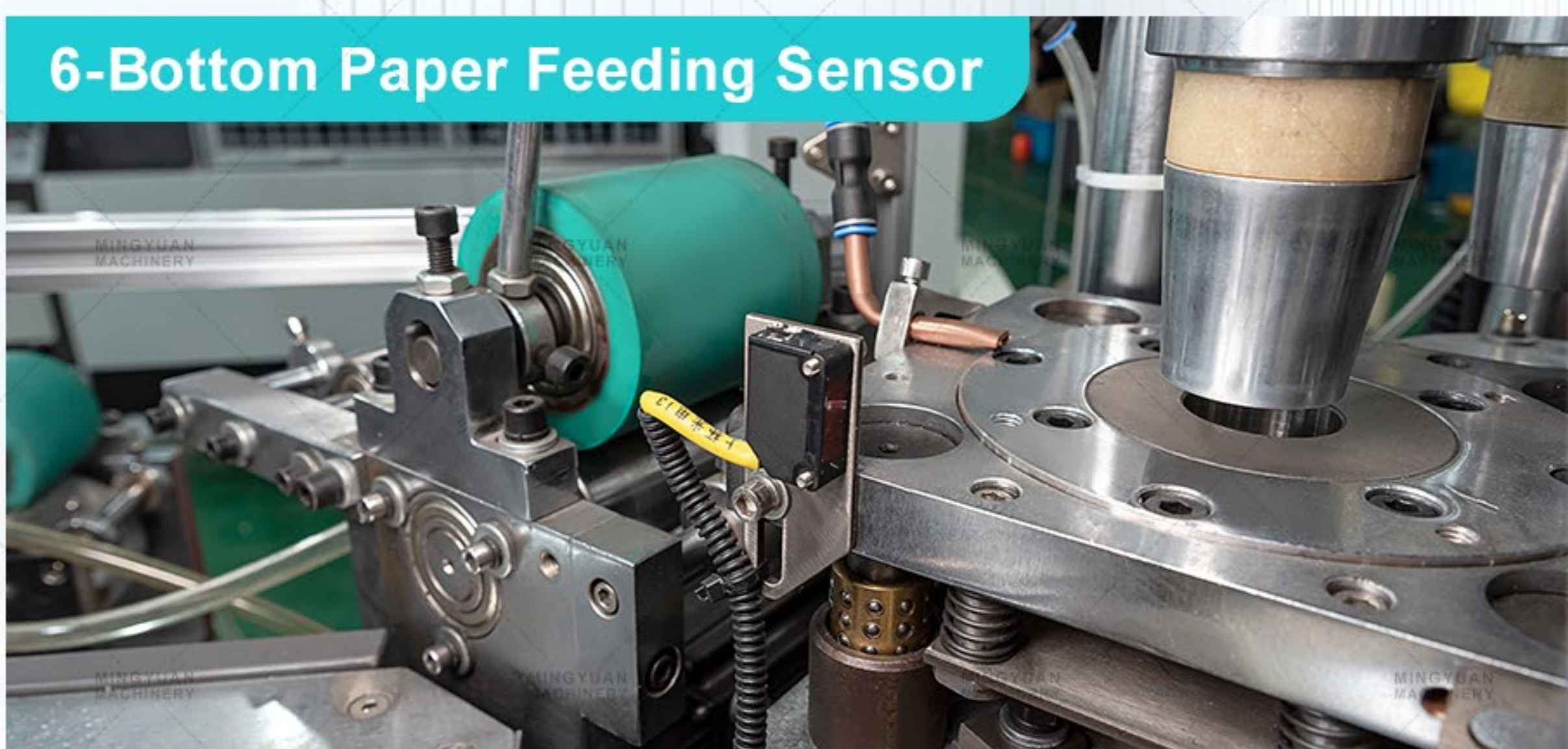

If it detects no cup in the mould , it will stop punching and feeding cup bottom

7-Bottom Waster Paper Blocking Sensor



If the bottom waster paper transferring gets blocked, it will send the alarm.

8-Bottom Paper Less Sensor

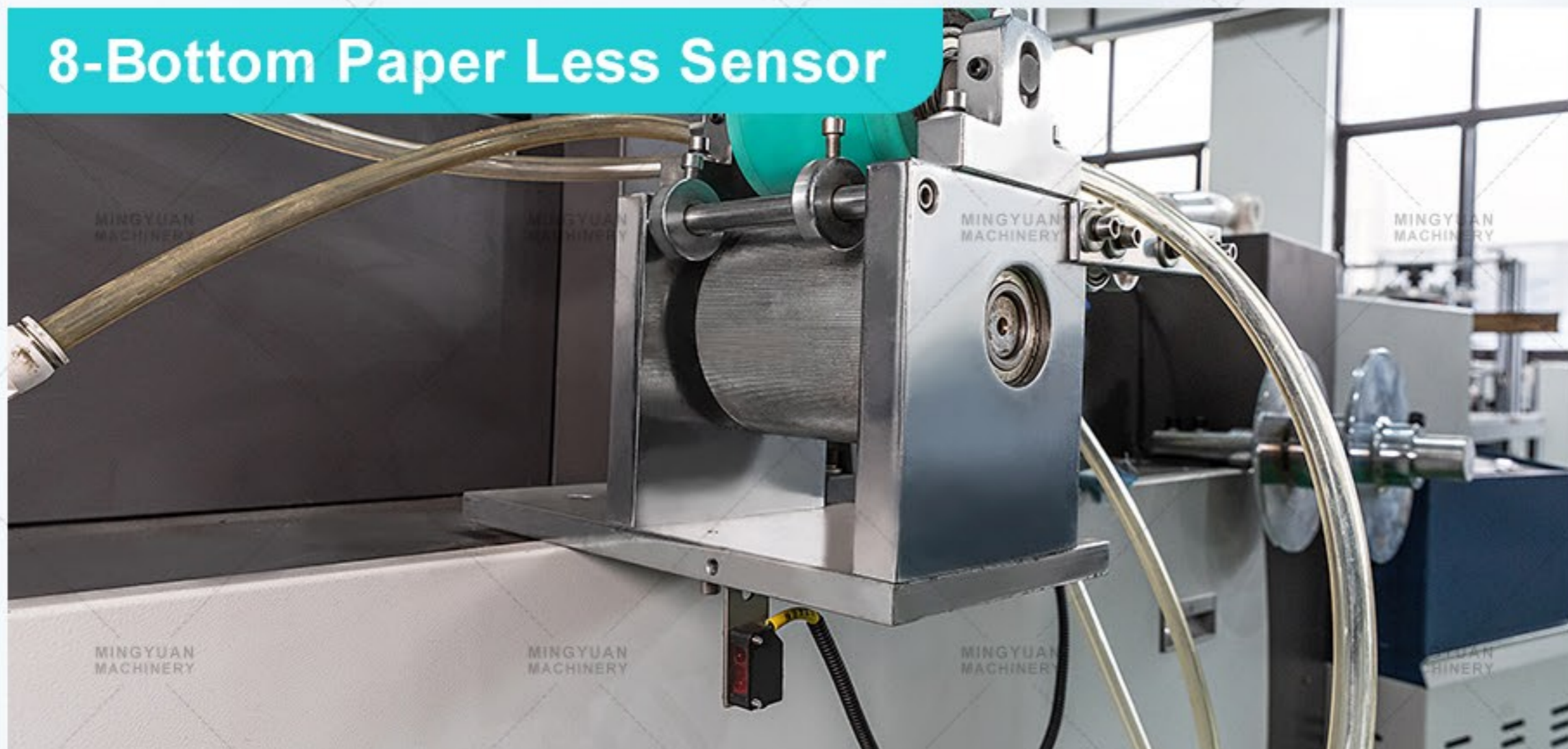

If the bottom paper is used up , the sensor will send alarm

Selling Points

09

Servo Motor

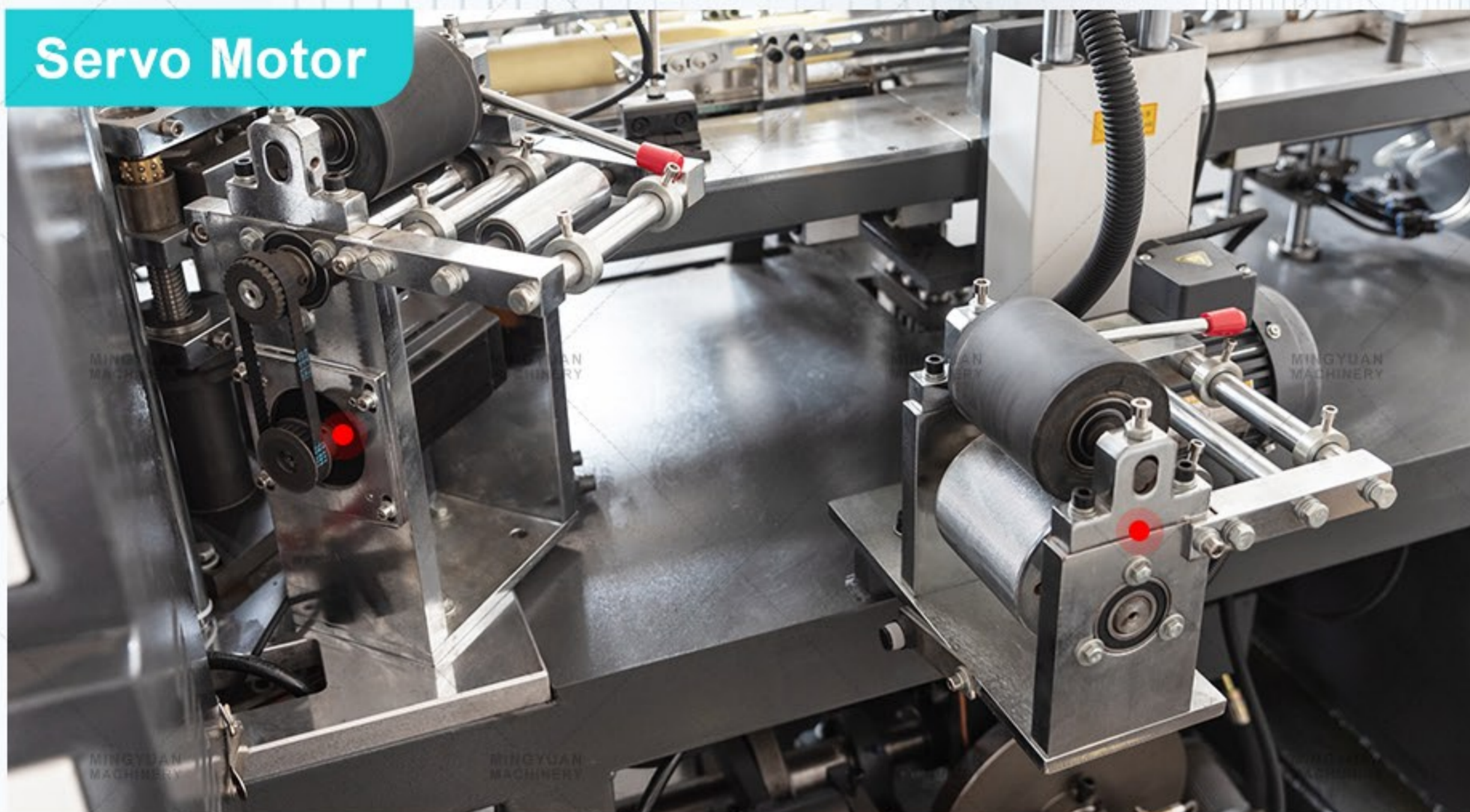

SERVO MOTOR



STEPPING MOTOR

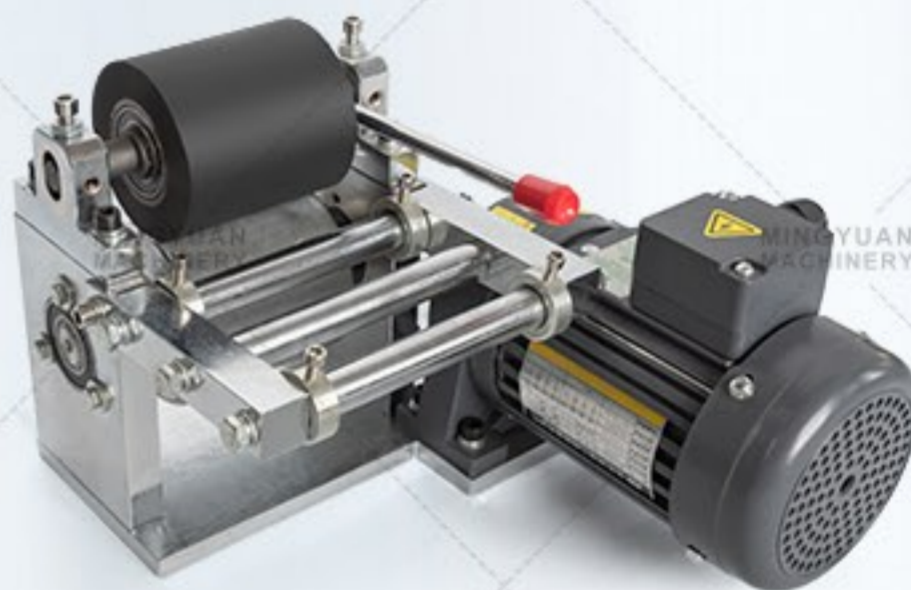

The bottom paper feeding is controlled by servo motor and stepping motor, which greatly improve paper feeding in high precision and high efficiency way. (more stable ,less troubles and save bottom paper)

Ruian Mingyuan Machinery Co., Ltd

MINGYUAN
MACHINERY

MINGYUAN
MACHINERY

MINGYUAN
MACHINERY

MINGYUAN
MACHINERY

Selling Points

10

Moving Cooling Fan



Two cooling fans, two fans can make the paper fan cooling faster, make the cup fan better sealing.

Touch Screen



It adopts PLC controller and touch screen (man-machine interface) all the working parameters can be setup on the control panel which is convenient for parameter setting and adjusting.(easy operate)

Ruian Mingyuan Machinery Co., Ltd

Selling Points

11

Oil Lubrication And Circulation

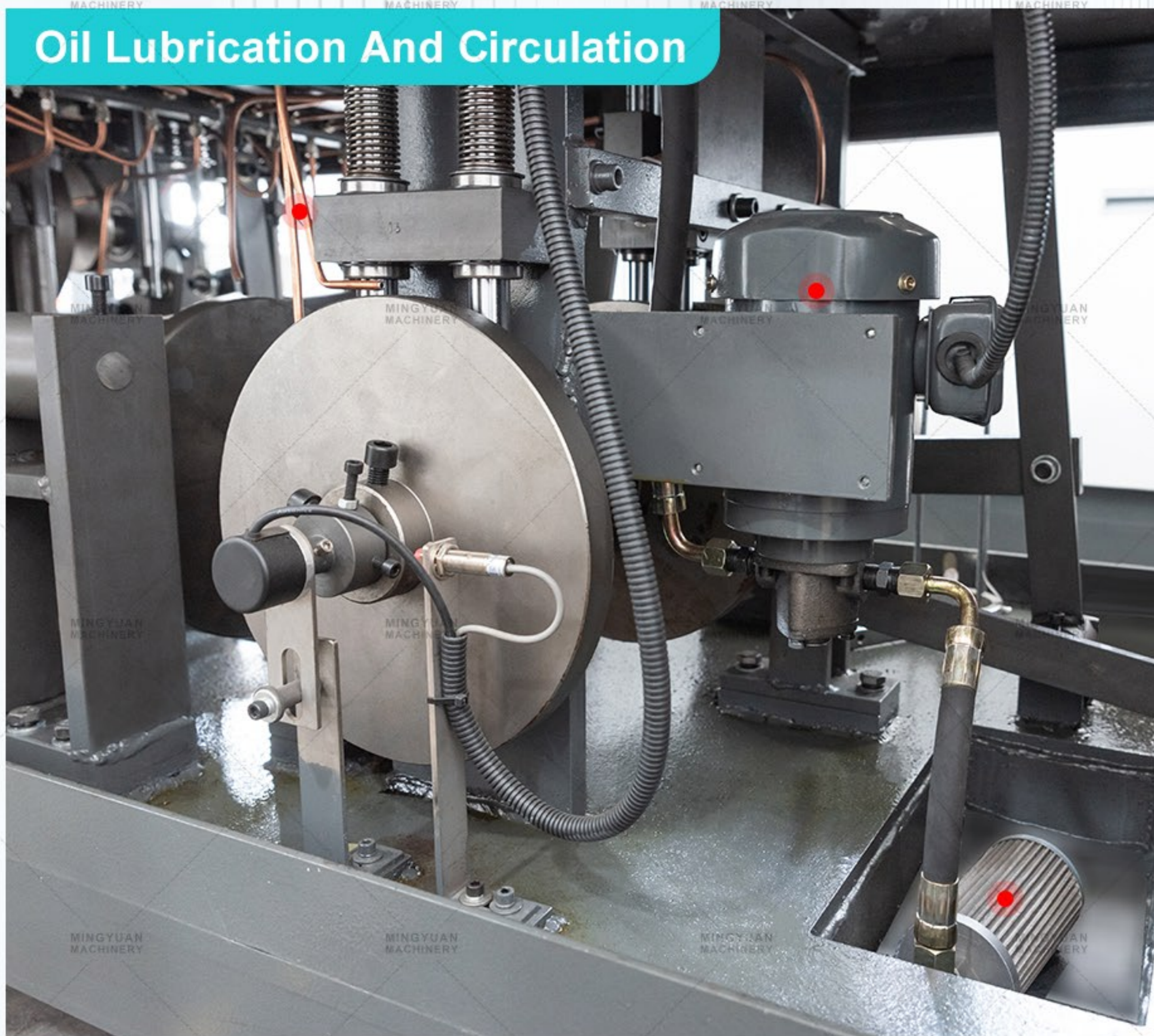

COPPER PIPE



OIL MOTOR

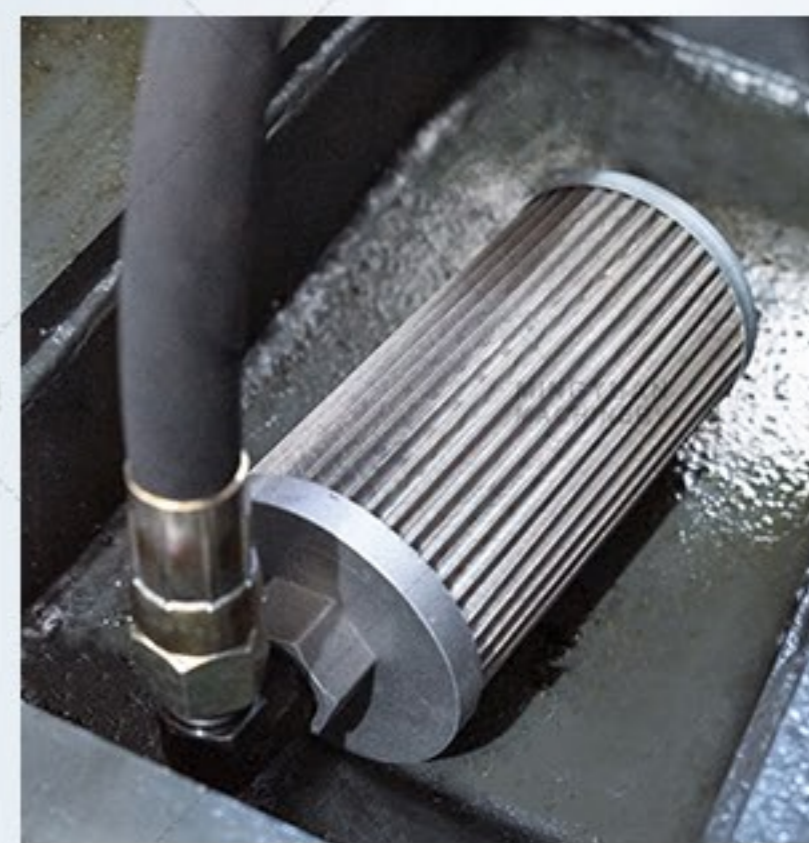

FILTER

The whole machine adopts automatic oil lubrication system (oil circulation system is including oil motor, filter, copper pipe) which makes all gear moving parts working at high speed much more smoothly and greatly Improve the service life of spare parts .

Ruian Mingyuan Machinery Co., Ltd

The Old And New Contrast

12

MINGYUAN
MACHINERY

MINGYUAN
MACHINERY

MINGYUAN
MACHINERY

MINGYUAN
MACHINERY

NEW DESIGN: TEN MOULDS

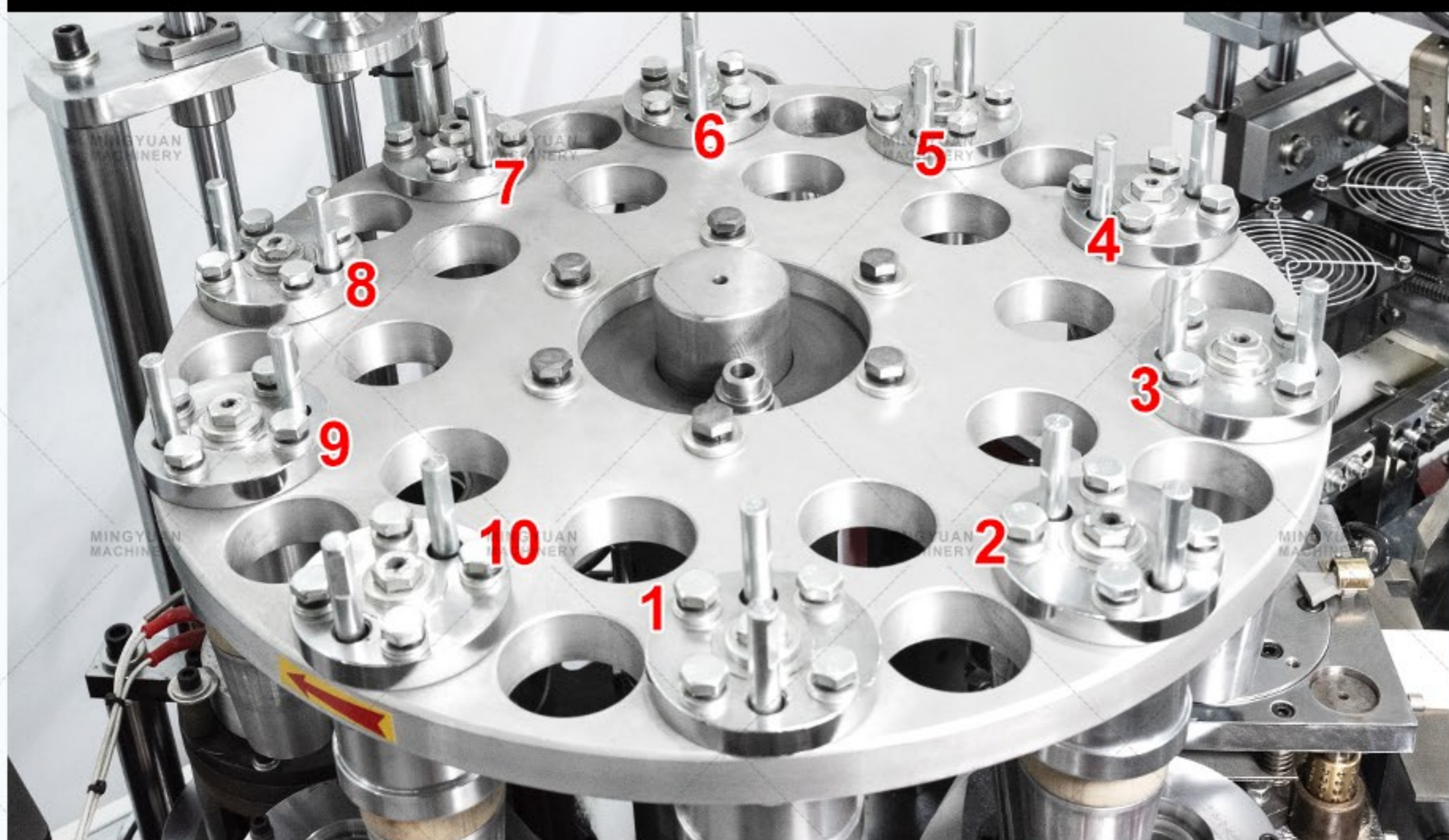

OLD DESIGN: EIGHT MOULDS



Main Turnplate: The main turnplate design is installed with ten moulds which can make speed faster.

MINGYUAN
MACHINERY

MINGYUAN
MACHINERY

MINGYUAN
MACHINERY

MINGYUAN
MACHINERY

Ruian Mingyuan Machinery Co., Ltd

The Old And New Contrast

13

MINGYUAN
MACHINERY

MINGYUAN
MACHINERY

MINGYUAN
MACHINERY

MINGYUAN
MACHINERY

NEW DESIGN: FOUR BOTTOM HEATER SYSTEM



OLD DESIGN: THREE BOTTOM HEATER SYSTEM



Bottom Heater System:The new design adds a bottom heating system more than the old design which make the paper cup sealing effect is more better.

MINGYUAN
MACHINERY

MINGYUAN
MACHINERY

MINGYUAN
MACHINERY

MINGYUAN
MACHINERY

Ruian Mingyuan Machinery Co., Ltd

The Old And New Contrast

14

MINGYUAN
MACHINERY

MINGYUAN
MACHINERY

MINGYUAN
MACHINERY

MINGYUAN
MACHINERY

NEW DESIGN: LARGE AND THICK

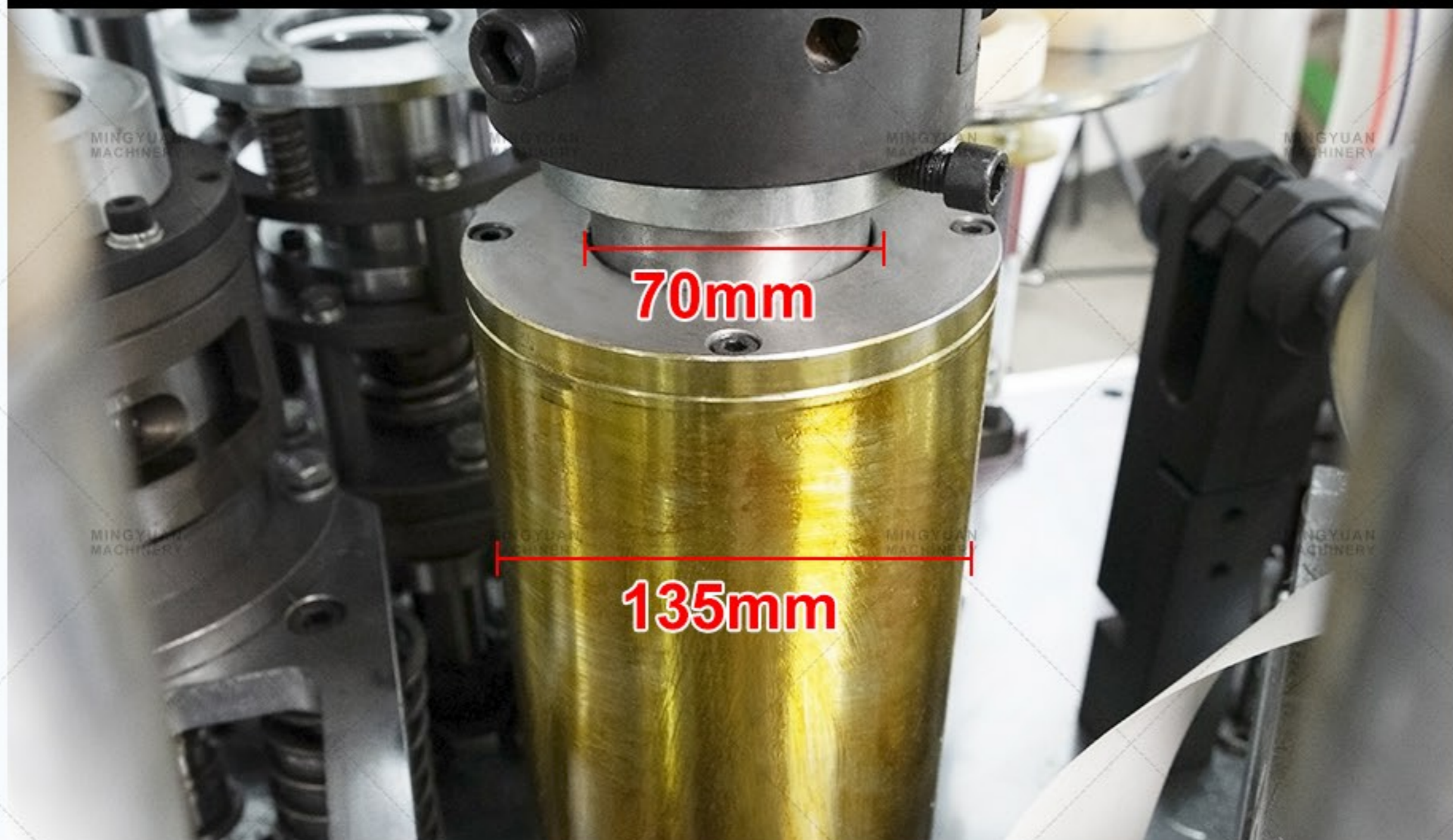

OLD DESIGN



Central Shaft: Large and thick central shaft makes machine run stably at high speed without shaking.

MINGYUAN
MACHINERY

MINGYUAN
MACHINERY

MINGYUAN
MACHINERY

MINGYUAN
MACHINERY

Ruian Mingyuan Machinery Co., Ltd

The Old And New Contrast

15

MINGYUAN
MACHINERY

MINGYUAN
MACHINERY

MINGYUAN
MACHINERY

MINGYUAN
MACHINERY

NEW DESIGN



OLD DESIGN

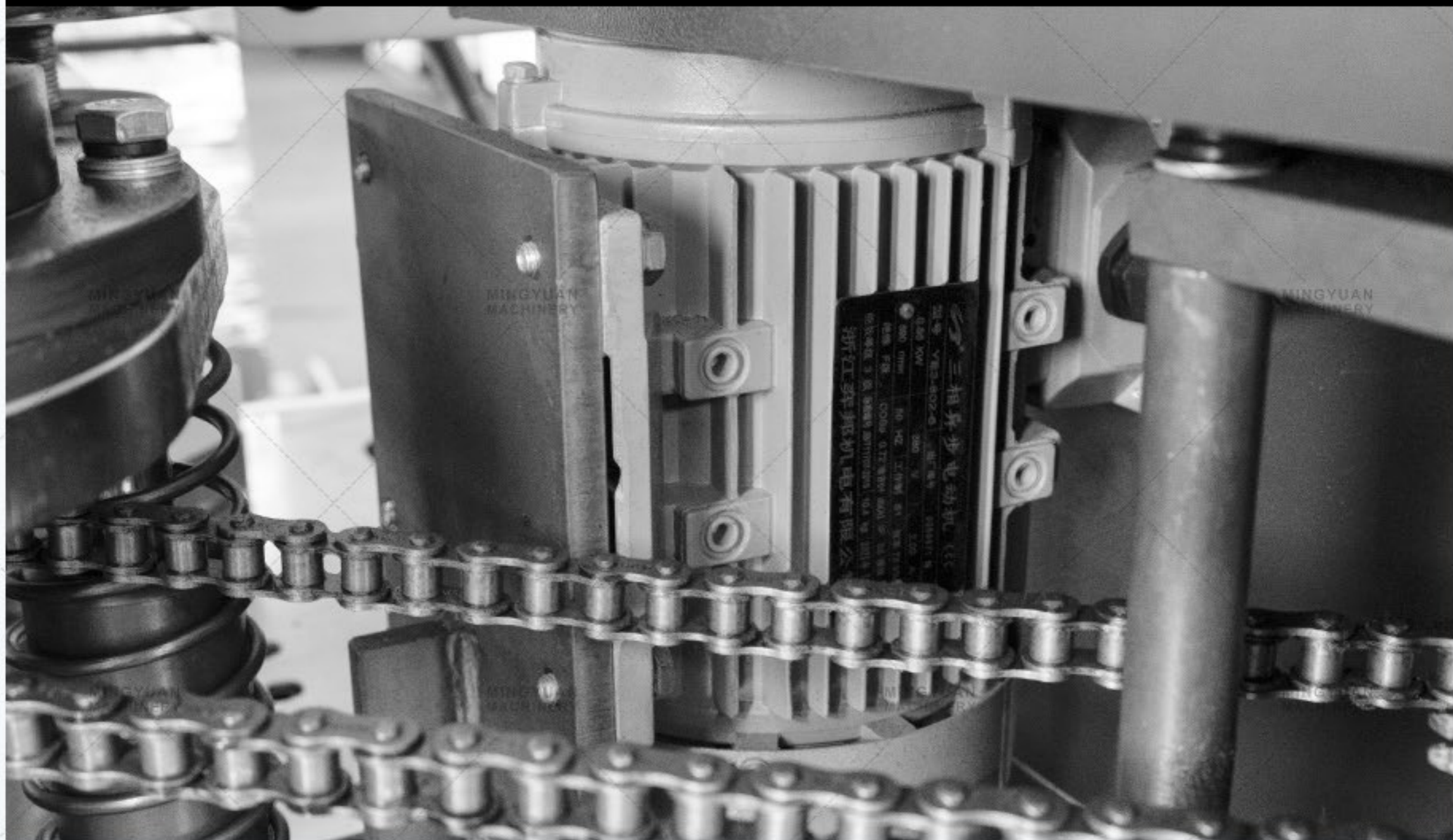

Integrated Knurling & Curling Motor: The integration of the motor is not easy to be damaged, and the old belt is easily damaged.

MINGYUAN
MACHINERY

MINGYUAN
MACHINERY

MINGYUAN
MACHINERY

MINGYUAN
MACHINERY

Ruian Mingyuan Machinery Co., Ltd

The Old And New Contrast

16

MINGYUAN
MACHINERY

MINGYUAN
MACHINERY

MINGYUAN
MACHINERY

MINGYUAN
MACHINERY

NEW DESIGN: INTEGRATED STEEL BOARD

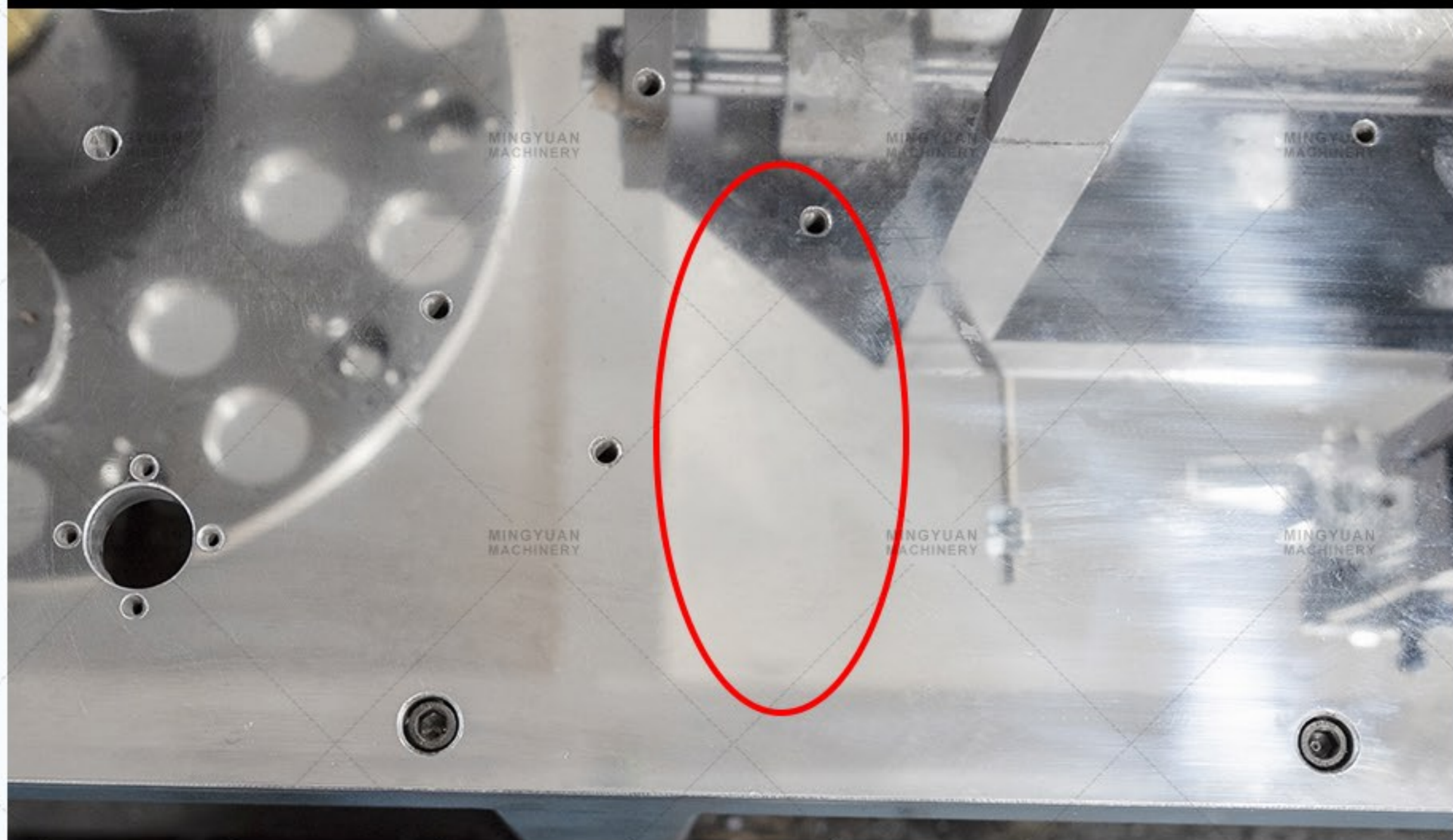

OLD DESIGN: SPLICING BOARD STRUCTURE

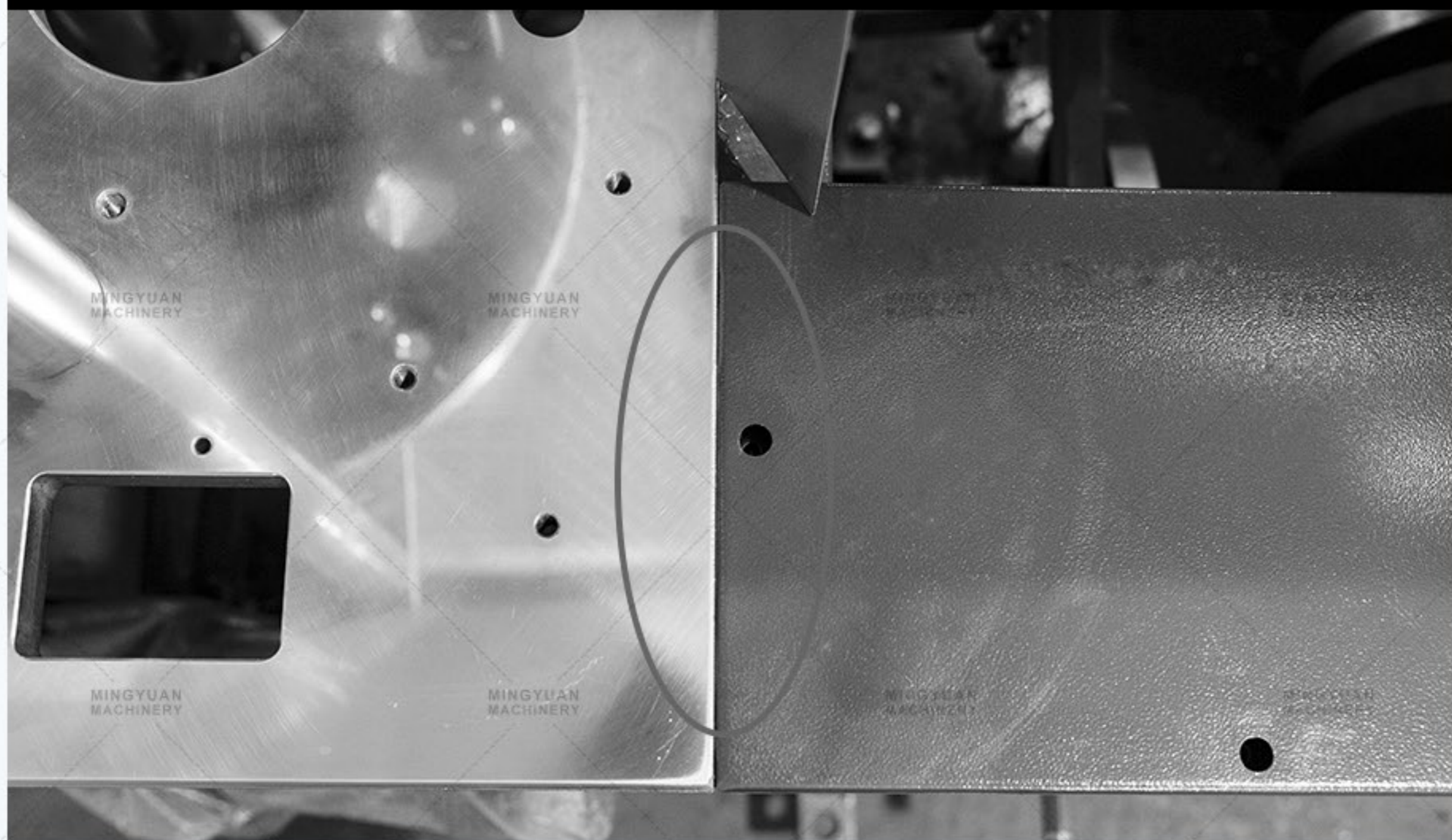

1. Integrated steel board: The operation board is large and thick integrated steel board, more durable and easy to clean.

2. Splicing board structure: the board frame is thin. Waste paper easily falls into the inside of the machine from the board gap.

MINGYUAN
MACHINERY

MINGYUAN
MACHINERY

MINGYUAN
MACHINERY

MINGYUAN
MACHINERY

Ruian Mingyuan Machinery Co., Ltd

Single Main Shaft

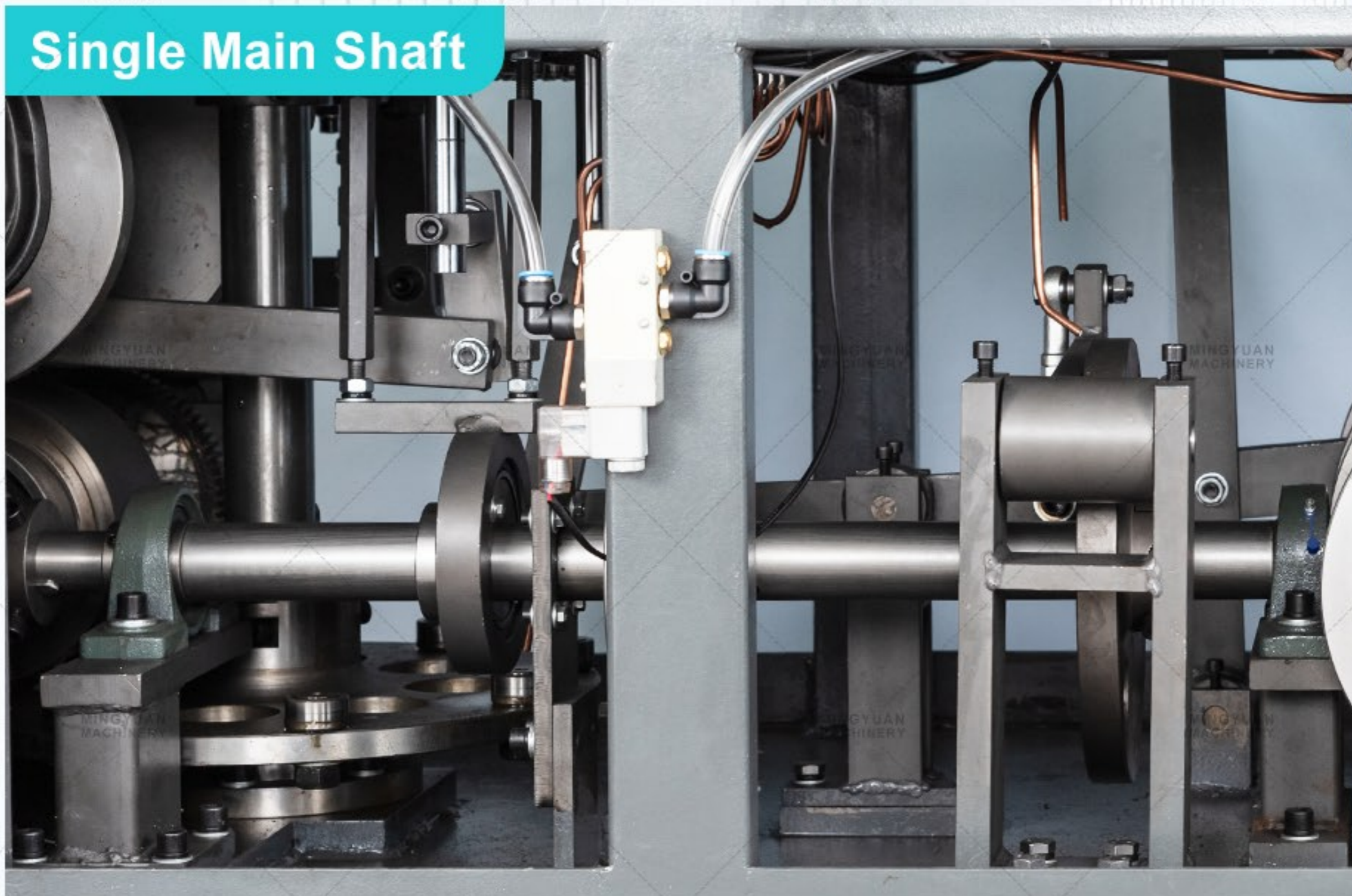

All Cams building on Main shaft which keep sure machine running stable and spare without out of location

Multi-function CAM

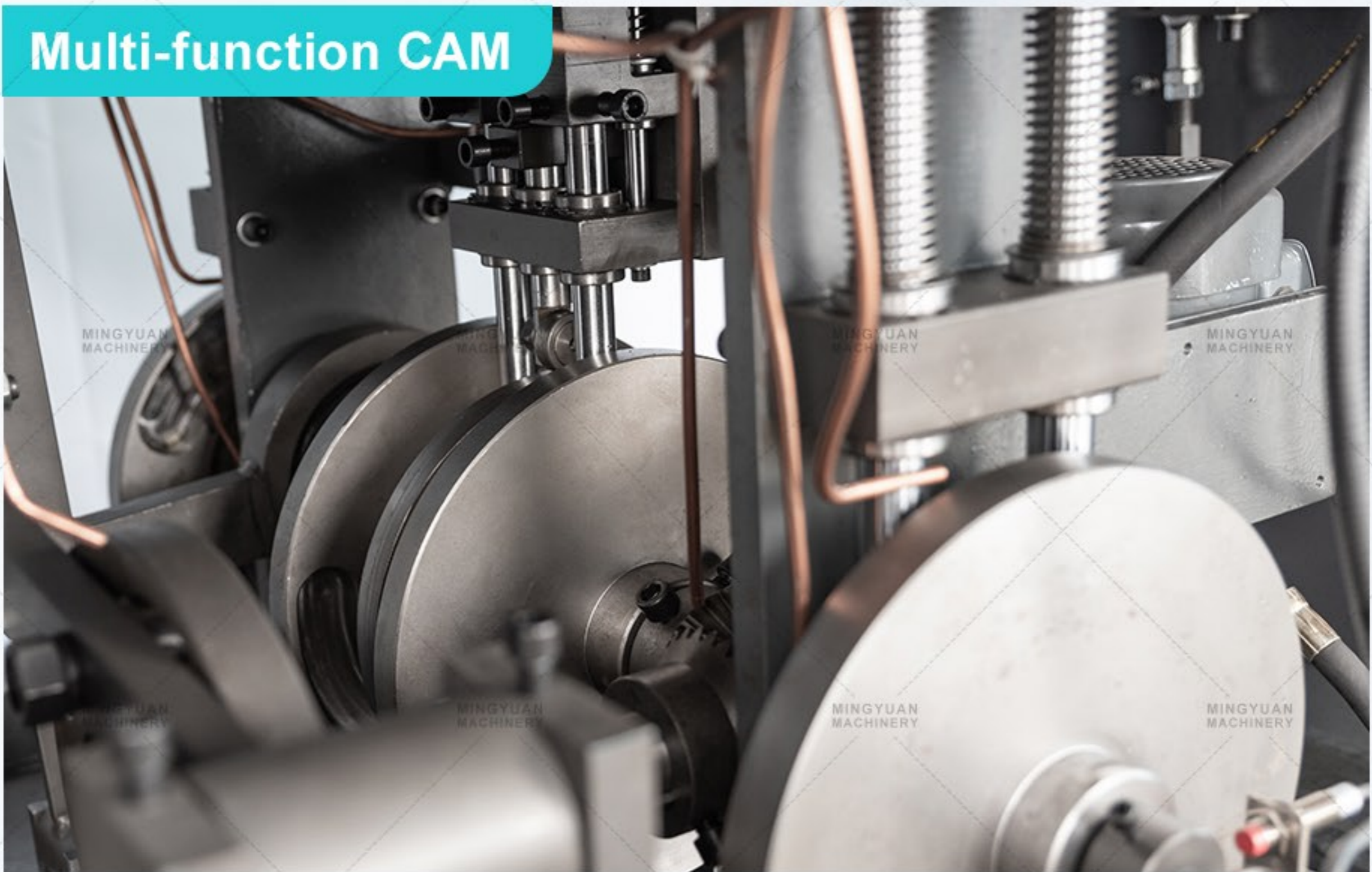

Three cams design are used to separately control the operation of the four spare parts which makes paper fan sealing more stable at high speed without troubles.

MINGYUAN
MACHINERY

MINGYUAN
MACHINERY

MINGYUAN
MACHINERY

MINGYUAN
MACHINERY

Safety Cover

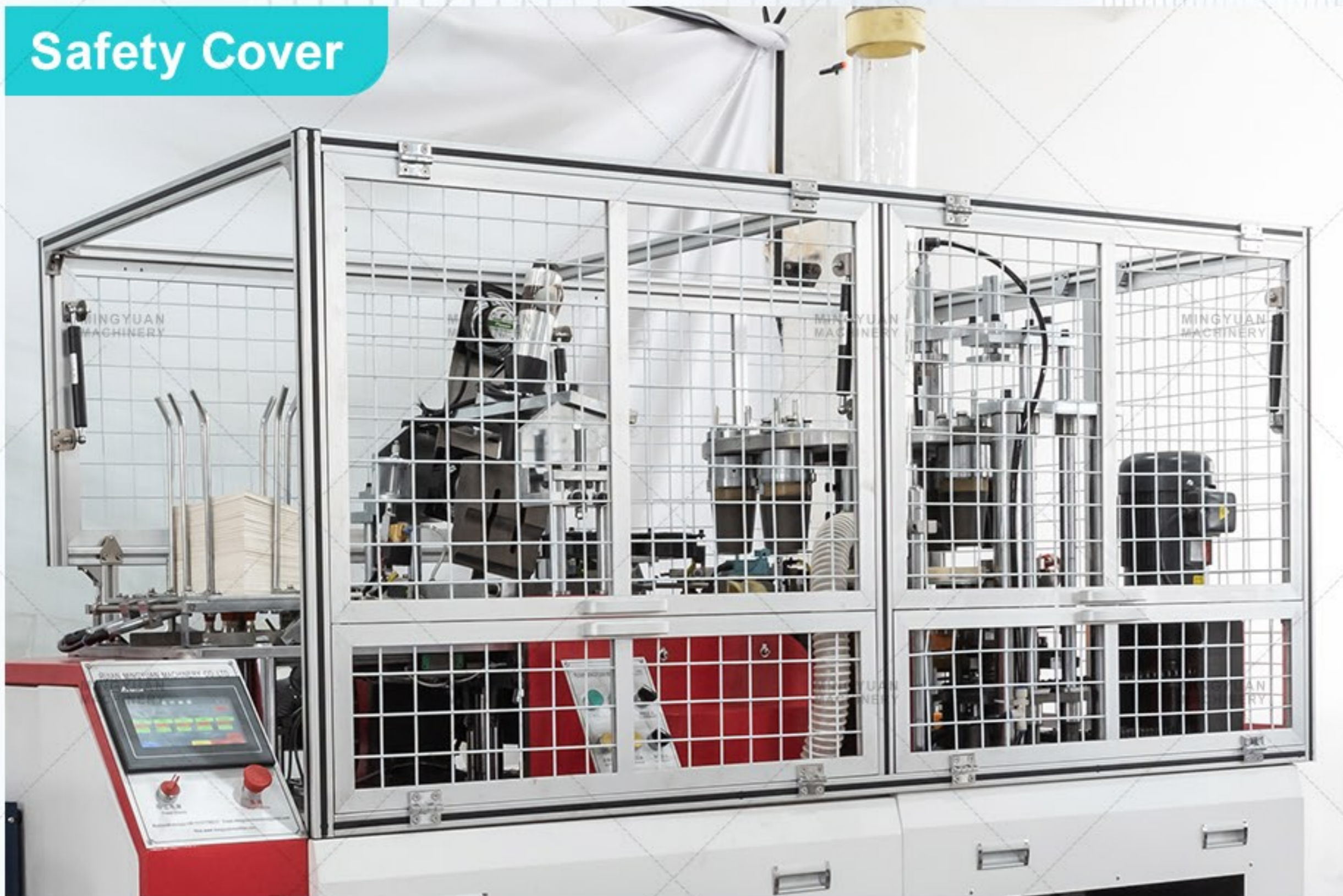

Protection during the operation of the machine

MINGYUAN
MACHINERY

MINGYUAN
MACHINERY

MINGYUAN
MACHINERY

MINGYUAN
MACHINERY

Robot Hand

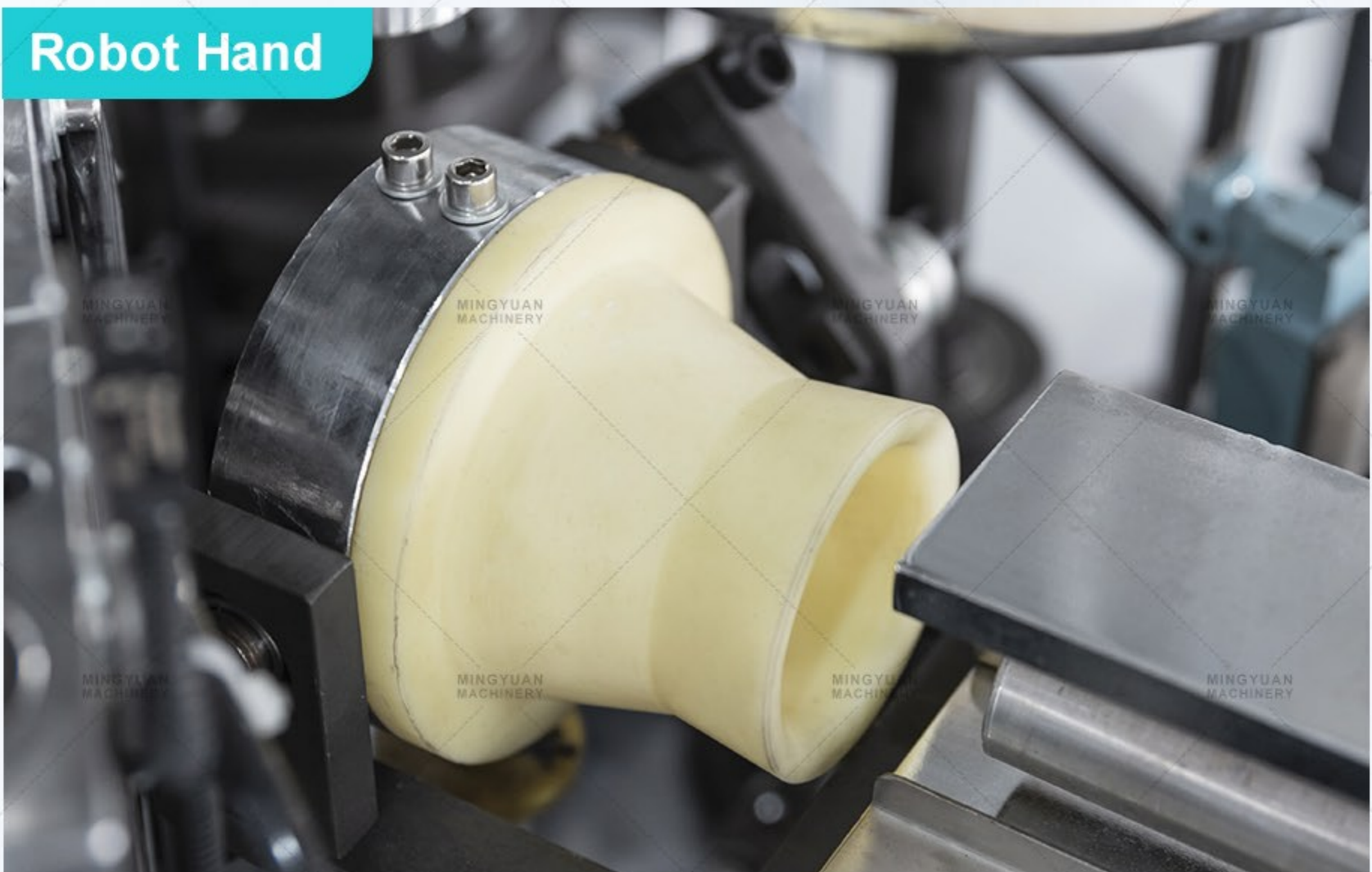

Catch and remove bowls easily.

MINGYUAN
MACHINERY

MINGYUAN
MACHINERY

MINGYUAN
MACHINERY

MINGYUAN
MACHINERY

Electric Components List

| Brand | Picture | Name |
|---|--|---|
|  |  | AC CONTACTOR 4 x PCS |
|  |  | CIRCUIT BREAKER 1 x PCS |
|  |  | CIRCUIT BREAKER 3 x PCS |
|  |  | MINIATURE RELAY 7 x PCS |
|  |  | PUSH BUTTON & ROTARY SWITCH 8 x PCS |
|  |  | THERMAL RELAY 1 x PCS |

Electric Components List

| Brand | Picture | Name |
|---|---|--|
|  |  | <p>SWITCHING POWER SUPPLY 1 x PCS</p> |
|  |  | <p>INVERTER 1 x PCS</p> |
|  |  | <p>PLC 1 x PCS</p> |
|  |  | <p>TOUCH PANEL 1 x PCS</p> |
|  |  | <p>ROTARY ENCODER 1 x PCS</p> |
|  |  | <p>AMPLIFIER BOARD 1 x PCS</p> |
|  |  | <p>SOLID STATE RELAY 4 x PCS</p> |

Free Tool Box

21

Picture

Name



**NIPPER
PLIERS**
1 x PCS

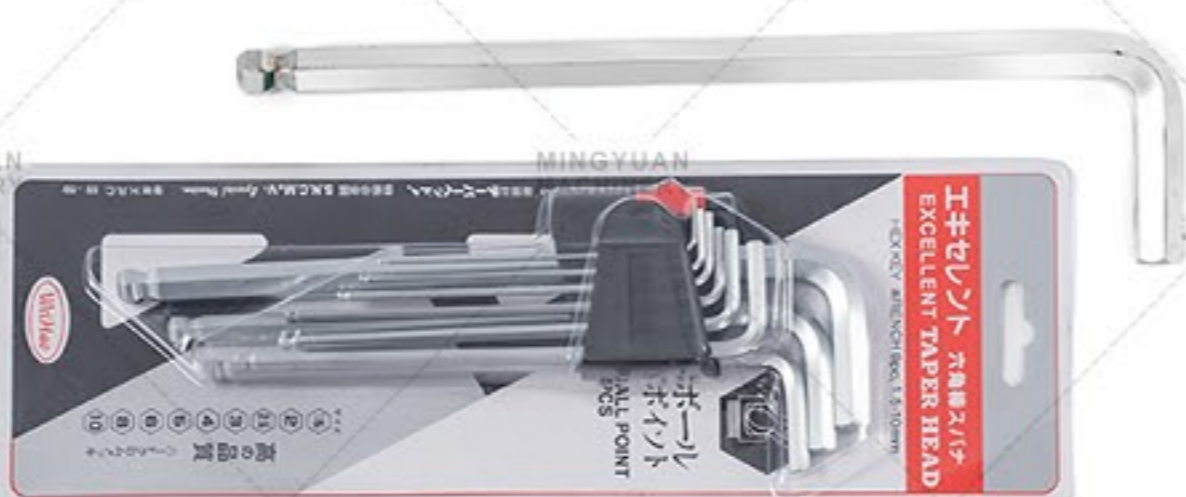

**INNER
HEXAGONAL
SPANNER**
1 x PCS



**OPEN-END
WRENCH**
1 x PCS



**SCREWDRIVER
(+ -)**
1 x PCS



**BOX END
WRENCH**
1 x PCS



BEARING
1 x PCS



**ELECTRICAL
TAPE**
1 x PCS



HAMMER
1 x PCS



**ADJUSTABLE
SPANNER**
1 x PCS



OIL GUN
1 x PCS

Ruian Mingyuan Machinery Co., Ltd

Free Spare Parts

22

Picture

Name



PREHEAT HEATING COLLAR
1 x PCS



PREHEAT HEATING COLLAR
1 x PCS



SUCKER
4 x PCS



SPRINGS
2 x PCS



SCREWS
1 x PCS



ALUMINIUM HEATER
7 x PCS

Rest Assured To Buy

We are a company
with solutions

AFTER-SALES VIDEO

YouTube



Warranty of Spare Parts

Spare Parts guarantee for
one year since client
received machine



Technical Engineer Support

Send technician for installation &
training, the cost cover by buyer
(round ticket, accommodation,
Salary of USD 150 Each day)



Operation Manuals & Online Supports

We will provide the operation CD
and manual, we also supply the 24 hours
online service.



Bussiness Support

We will offer the most professional
suggestion to help you start and
expand your business

Ruian Mingyuan Machinery Co., Ltd

Good Service Win Client Trust

24

We will send the ultrasonic control box by DHL .

下午3:20 ✓✓

Hi Andy,
Thanks for listening.
In fact, you are fantastic. I will never change suppliers ...

 **Reliable Quality**

Ok, you, your Company is so much cooperative. I always remember your company.

下午2:49

 **Excellent Service**

Thank you. 下午2:50 ✓✓

Ok, Some one call me from Dhaka to know about machine. I tell him my experience.

下午3:02

de the production line will be fine we will buy you 5 more machines

07:55

 **Trustworthy**

dont worry, we have more than 12years exprience in manufacture and export

07:56 ✓✓

It will be a pleasure collaborate with you company ASAP

下午4:21

 **Pleasure Cooperation**

. It is nice to cooperate

下午4:22 ✓✓

Ruian Mingyuan Machinery Co., Ltd

Company View Image

MINGYUAN MACHINERY

MINGYUAN MACHINERY

MINGYUAN MACHINERY

MINGYUAN MACHINERY



MINGYUAN MACHINERY

MINGYUAN MACHINERY

MINGYUAN MACHINERY

MINGYUAN MACHINERY

Other Machine



Intelligence Paper Cup Machine



High Speed Paper Lid Machine



Hydraulic Paper Plate Machine



Intelligence Paper Bowl Machine



Paper Cup Sleeve Machine



Intelligence Paper Bucket Machine