

Simple Model

80-100 PCS-MIN

MINGYUAN
MACHINERY

MINGYUAN
MACHINERY

MINGYUAN
MACHINERY

Ruian Mingyuan Machinery Co., Ltd

Paper Cup Machine

MYC-OCM12

MINGYUAN
MACHINERY

MINGYUAN
MACHINERY



MINGYUAN
MACHINERY

MINGYUAN
MACHINERY

MINGYUAN
MACHINERY



MINGYUAN

MINGYUAN
MACHINERY

MINGYUAN
MACHINERY

MINGYUAN
MACHINERY

CATALOGUE



Catalogue Of Product Album

01 Parameters

P03-04

02 Mould selection

P05

03 Heating sealing option

P06-07

04 Principle video

P08

05 FAQ

P09-10

06 Advantages

P11-15

07 Electric list

P16

08 Free spare parts

P17-18

09 After-sales

P19-20

10 Certificates

P21

11 Company view image

P22

12 Other machine

P23



Click to jump to pages

Product Parameters



MINGYUAN MACHINERY

MINGYUAN MACHINERY

MINGYUAN MACHINERY

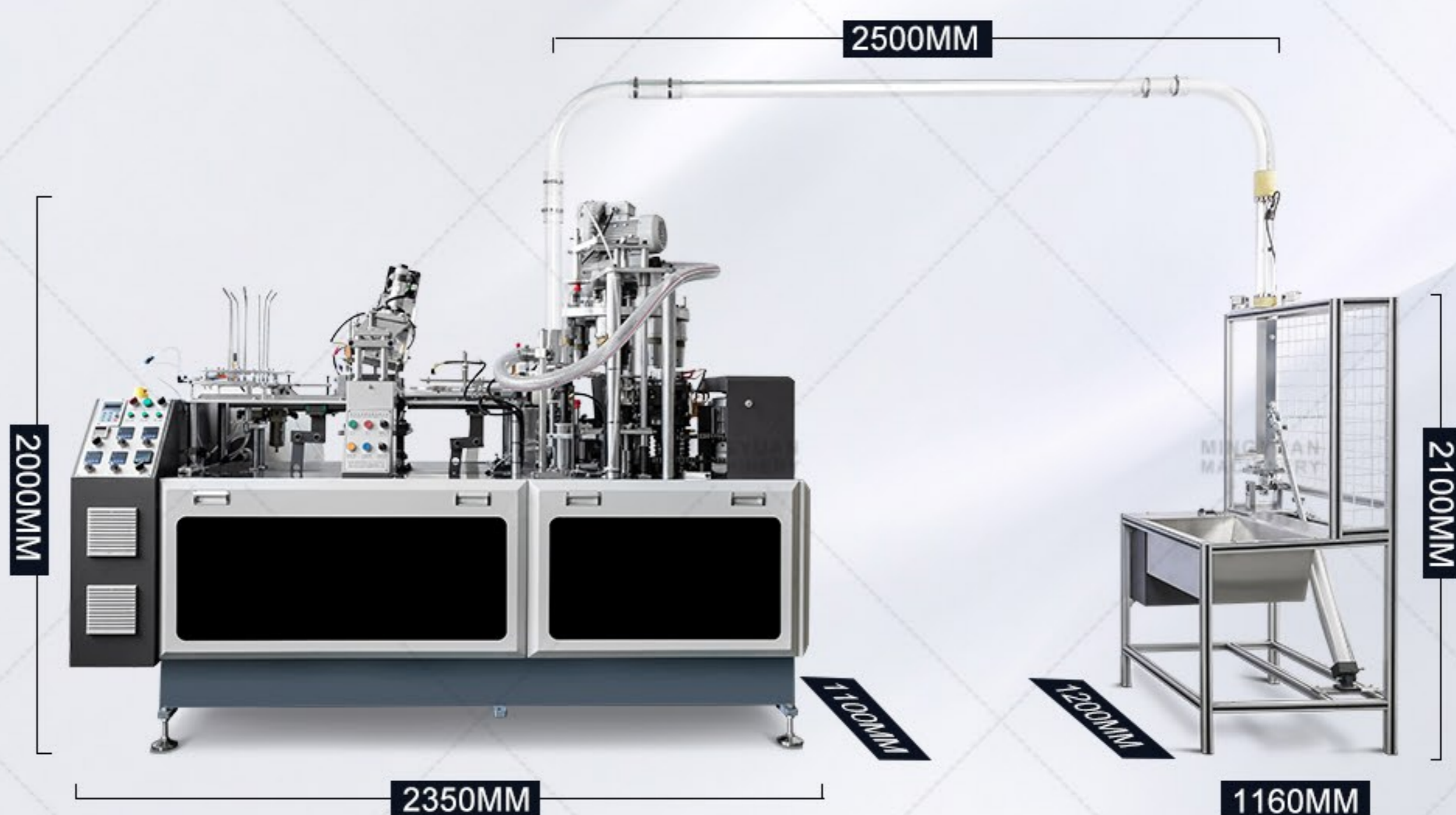

Image



Model

High Speed Simple Model Paper Cup Machine MYC-OCM12

Cup Side Welding

Copper Heater

Ultrasonic heater

Paper Cup Size

1.5 ~16 OZ (Mould exchangeable, Max Cup Height:136mm , Max Bottom width :80mm)

Rated Speed

80-100pcs/min (Speed affected by cup size, paper quality & thickness)

Raw Material

Only one-side PE coated paper (Popular for Hot drink cups)

One or Two side PE coated Paper (Popular for Hot and Cold drink Cups)

Suitable paper weight

140-250gsm

140-350gsm

Power Source

50/60HZ, 380V/220V (better use 380V, 3 Phase) or special Power requirement.

Total Power

4 KW

6 KW

Total Weight

GW/NW: 2000KG/1900KG

Pack Size (L*W*H)

2350*1110*2000mm(Machine size)
1160*1200*2100mm(Collecting table size)

Working Air Source

No need provide Air

Air pressure:0.4Mpa;
Air Out-put:0.6m³/minute
Need to buy Air Compressor(by user)

Cup Bottom Heating

Heater Knurling

1side PE paper by heater knurling;
2side PE paper by cool device (circle water) knurling.

Cup Bottom Knurling

Heater Knurling (If use single PE coated paper)

OEM (Show Client Company Name in Machine Panel) is welcome in our factory

TOP VIEW

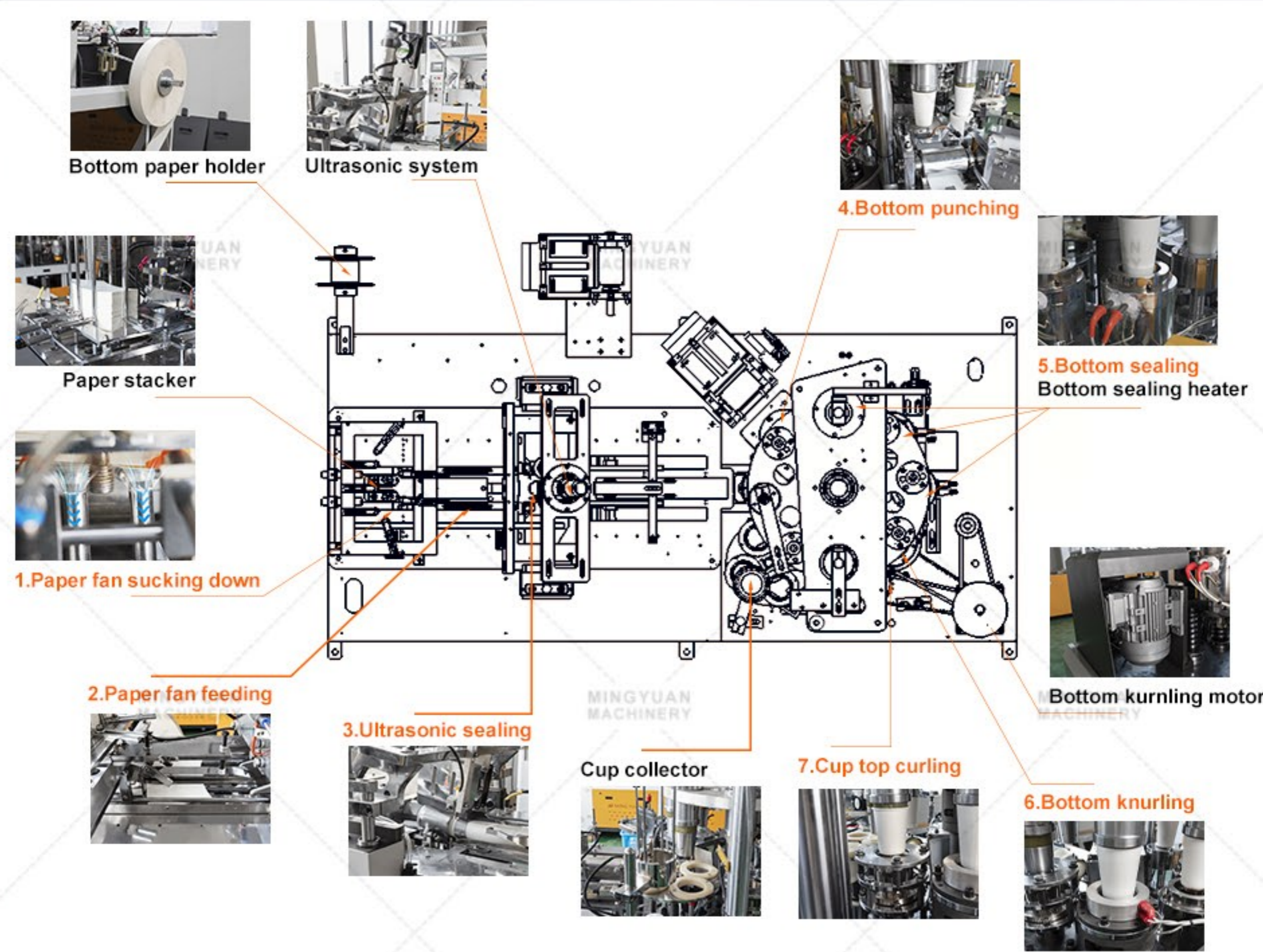

Cup Size Range

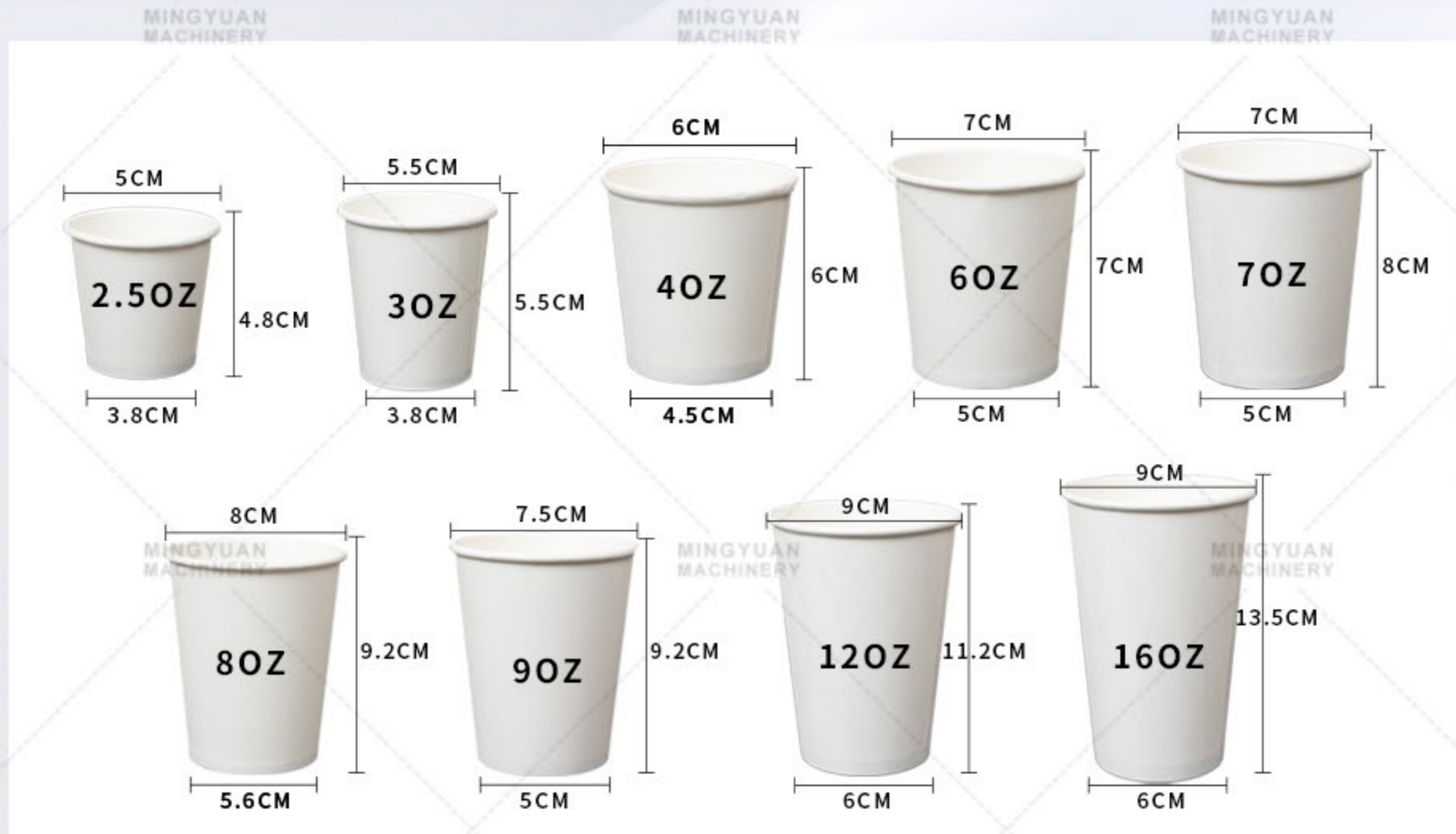

Cup Bottom Diameter:	Min 32mm ~ Max80mm
Cup Top Diameter:	Min 45mm ~ Max100mm
Cup Height:	Min 30mm ~ Max136mm
Bottom Knurling Depth:	Min 4mm ~ Max 10mm (popular 5mm)
Top Curling Rim Diameter:	Popular about 2.5Φ~3Φ



Difference in Full and Half Set Mould

MINGYUAN MACHINERY



Full Set Mould

MINGYUAN MACHINERY

MINGYUAN MACHINERY

MINGYUAN MACHINERY

Different Size Cups with different bottom diameter and angle, (Difficult to change mould). We NO Suggestion Client to change Full Set Mould which easy be trouble of machine. For One Set machine is better goes with 1-2 extra half sets mould



Half Set Mould

Different Size Cups with same bottom diameter and angle, Just different size in cup height and Top Dia.



Paper Fan Heating Sealing Option



Ultrasonic Heater

Ultrasonic heater suitable for sealing the Single PE / Double PE paper.
Paper weight 140GSM-350GSM.



Copper Heater

Copper heater suitable for sealing the Single PE,
Paper weight 140GSM-250GSM



Ultrasonic Heater System



Ultrasonic heater system is with electric control box and voltage regulator which is provided for free to protect the ultrasonic electric system



Ultrasonic Electric Control Box



Ultrasonic Electric Control Box



If the voltage is 380v, you need to connect a voltage regulator, if it is 220v, you don't need it

(above spare parts are only available in ultrasonic heater machine)

Paper Cup Forming Process

MINGYUAN MACHINERY

MINGYUAN MACHINERY

MINGYUAN MACHINERY



Paper Cup Machine Principle Video

CLICK TO WATCH



MINGYUAN MACHINERY

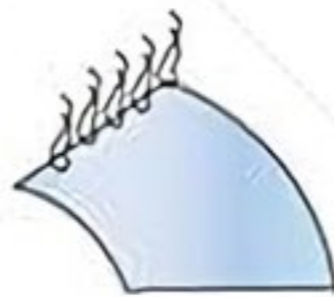

MINGYUAN MACHINERY

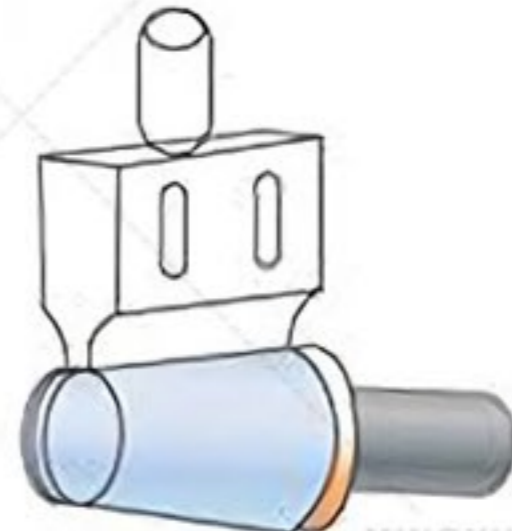

MINGYUAN MACHINERY



MINGYUAN MACHINERY



MINGYUAN MACHINERY



MINGYUAN MACHINERY



MINGYUAN MACHINERY

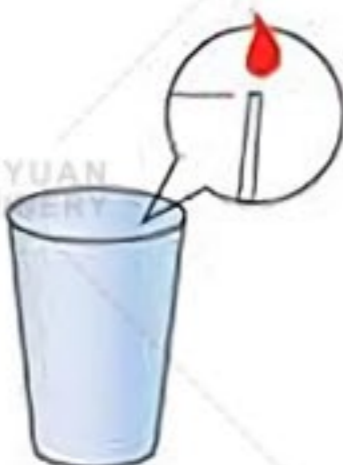

MINGYUAN MACHINERY



MINGYUAN MACHINERY



MINGYUAN MACHINERY



MINGYUAN MACHINERY

FAQ of Paper Cup Machine



MINGYUAN MACHINERY



Q How will the machine be repaired if there are faults, and what is the warranty?

A Our engineer team will send the **operation video** to guide you to solve the problem .if the spare parts is broken in the warranty period, we will send you the **new replacement parts for free.**



Q What is the raw materials for the paper cup machine ?

A Raw materials : **Single /double PE coated paper fan** which is already cut and printed , **bottom paper roll** .
PS: Machine is without printing and cutting function(only can cut bottom roll paper, it can not cut the paper fan)



Q What else we need to start the production ?

A Food grade or silicone oil and a small air compressor.
(No air heating without compressor)



MINGYUAN MACHINERY

MINGYUAN MACHINERY

MINGYUAN MACHINERY

FAQ of Paper Cup Machine

MINGYUAN
MACHINERY

Q One machine is with just one mould or several mould?
Can we make difference size of the cup in one machine?

A One machine is installed one full set mould for free. You can buy extra half set mould (easy to change) or full set mould (difficult :1% success rate). We only recommend to change 1-3 sets half set mould (with same bottom diameter size) in one machine .

Q What is the delivery time after the order ?

A We have only half finished machine (no mould) in stock. The mould design is customized as each **customer requirement**. The mould production costs 20 days,10 days for the installation. The delivery time is **30-35 days** after the deposit payment .

Q How can I install the machine and get training services in my country?

A The machine will be finished installation and tested running perfectly before the delivery . You will get the complete machine which is finished installation. We will provide the full operation and training Videos to guide you to run the machine . Anyone can install the machine and operate it easily.

Q What is the power consumption?
what is the Voltage and Phases can the machine use?

A The total power is around **4.5KW** , the Voltage can be **380 V three phases , 220V single /three phases** . the electric system can be customized as client requirement.

Advantages Comparisons



Mould with Air Hole



It can cool the mould easily and make the cup discharge easily.

Cover Platen Board

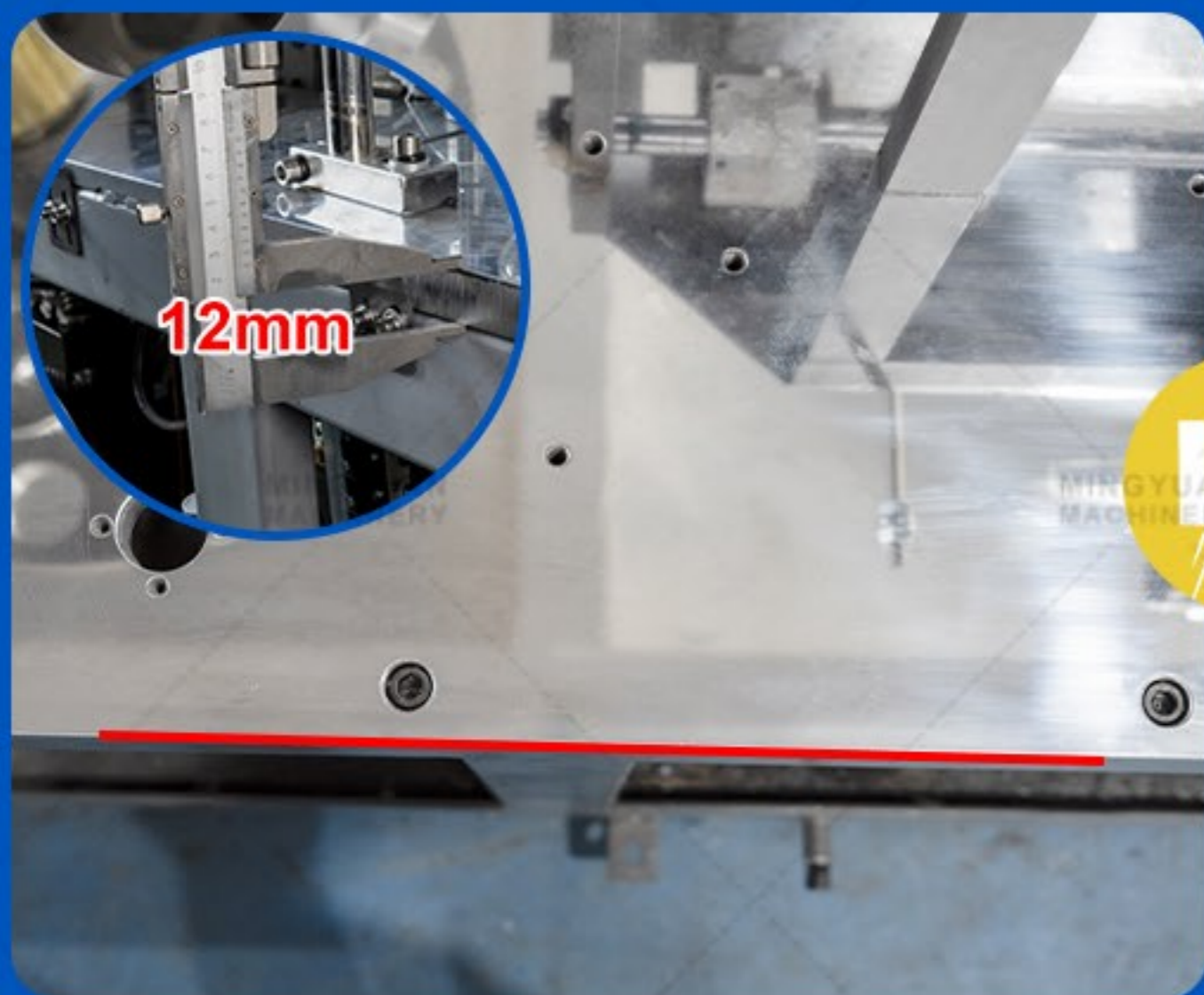

Longer service life
More stable and better.

Other Design



The cup will be stuck to the mould and cause issues.

Other Design

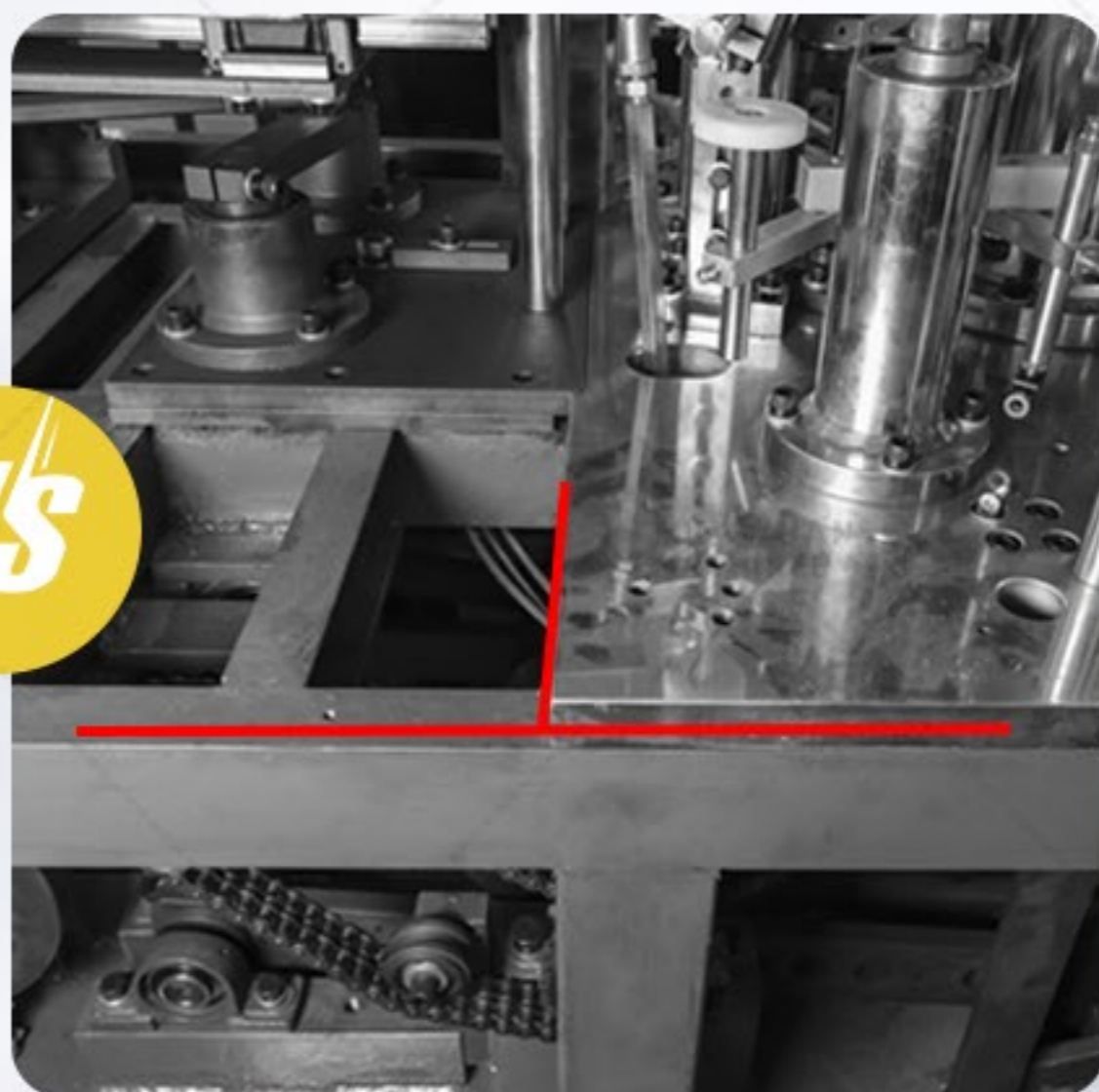

Thinner board and it is easy get rusted and broken.

Advantages Comparisons



Vaccum Suction Generator



Prevent wet air with water from entering solenoid valve, longer service life, more stable and better.

Metal Rod Accessories Thickness Upgrade

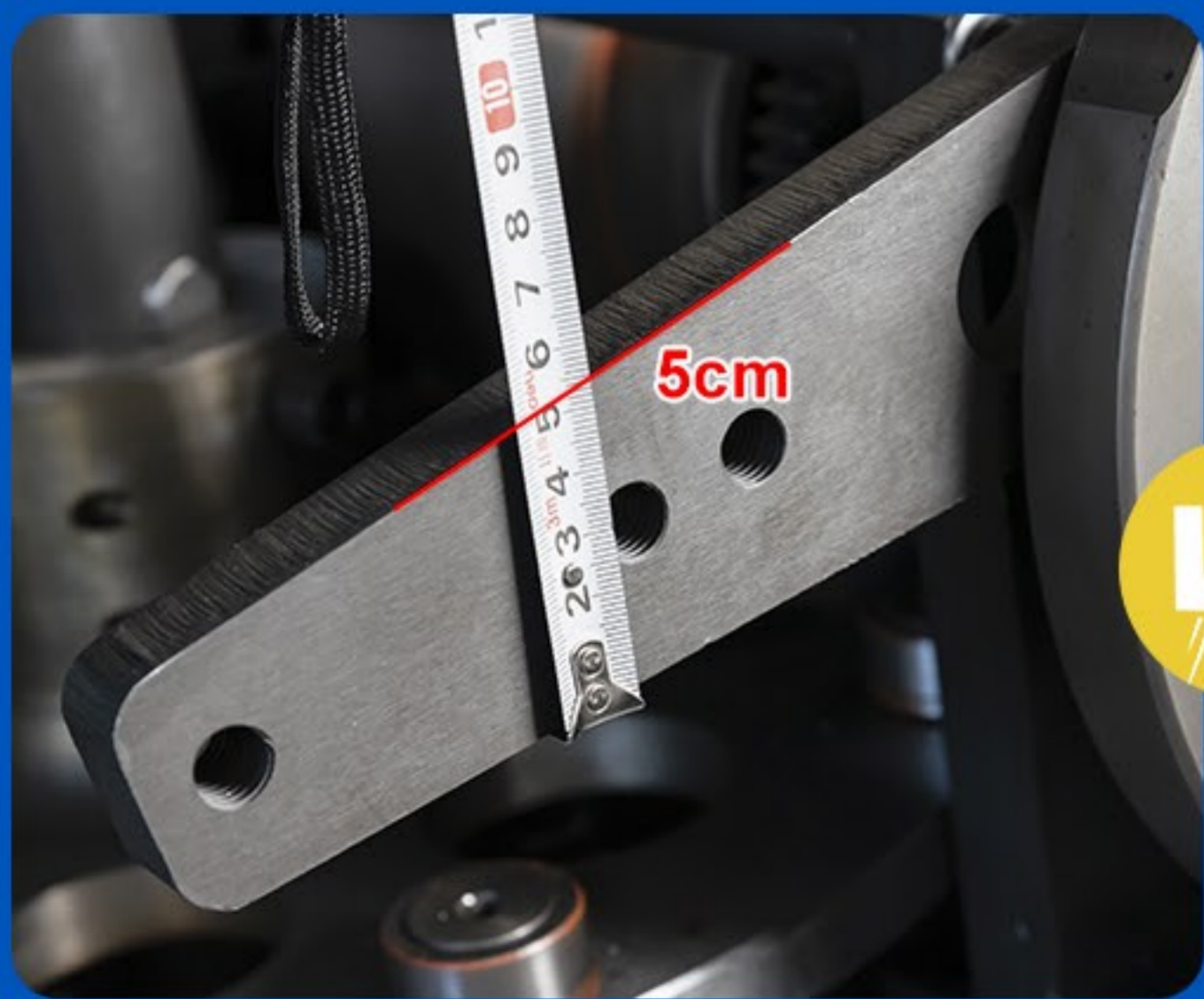
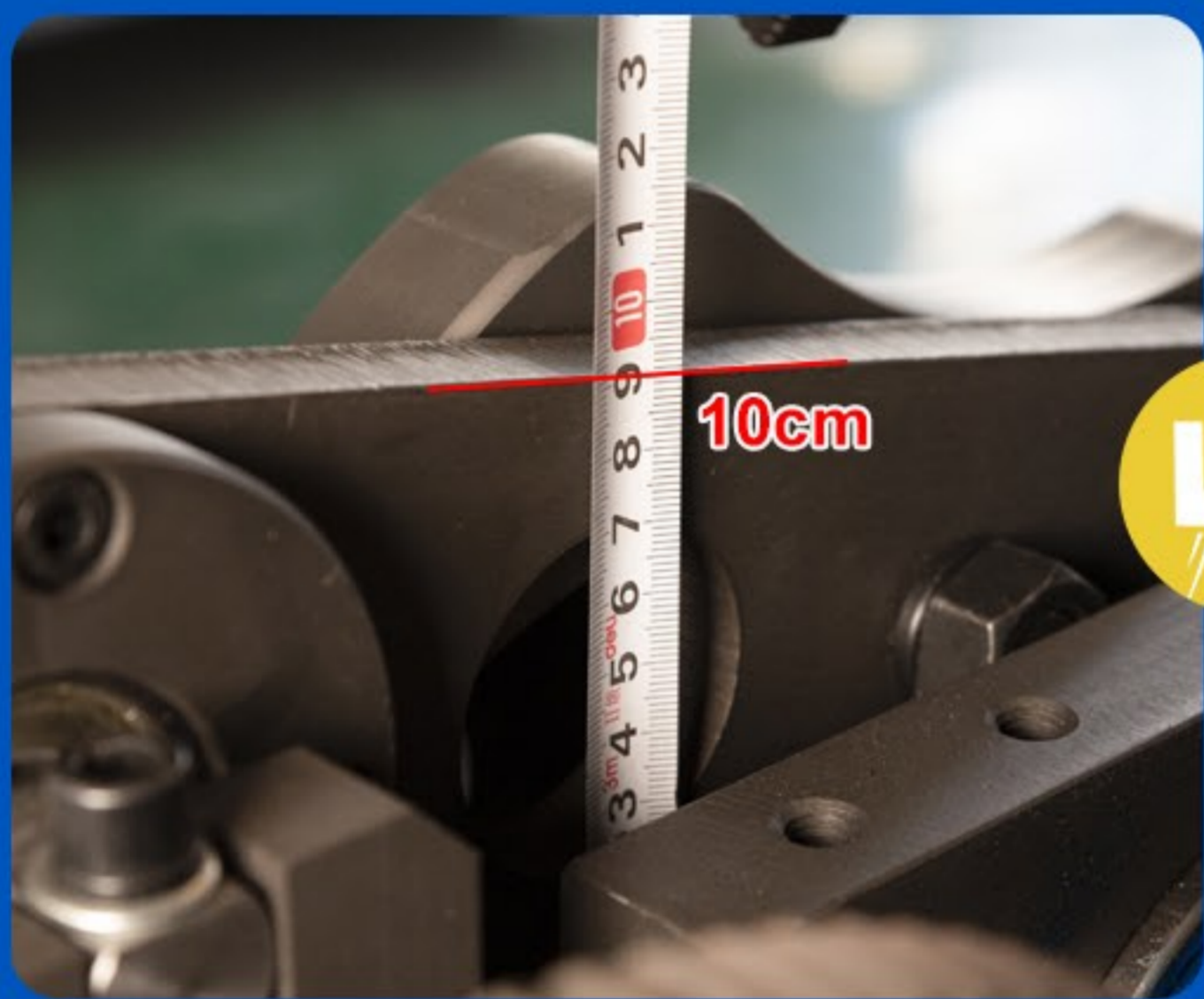

New design is durable better quality is not easy to be broken in long time running.

Air cylinder



paper suction is controlled by air cylinder, long time running will make the air sealing ring very hot and be broken easily, and cause air leaking issue.

Old Design



The rod will be break easily in short time running.

Advantages Comparisons



Metal Pipes



Normal Design

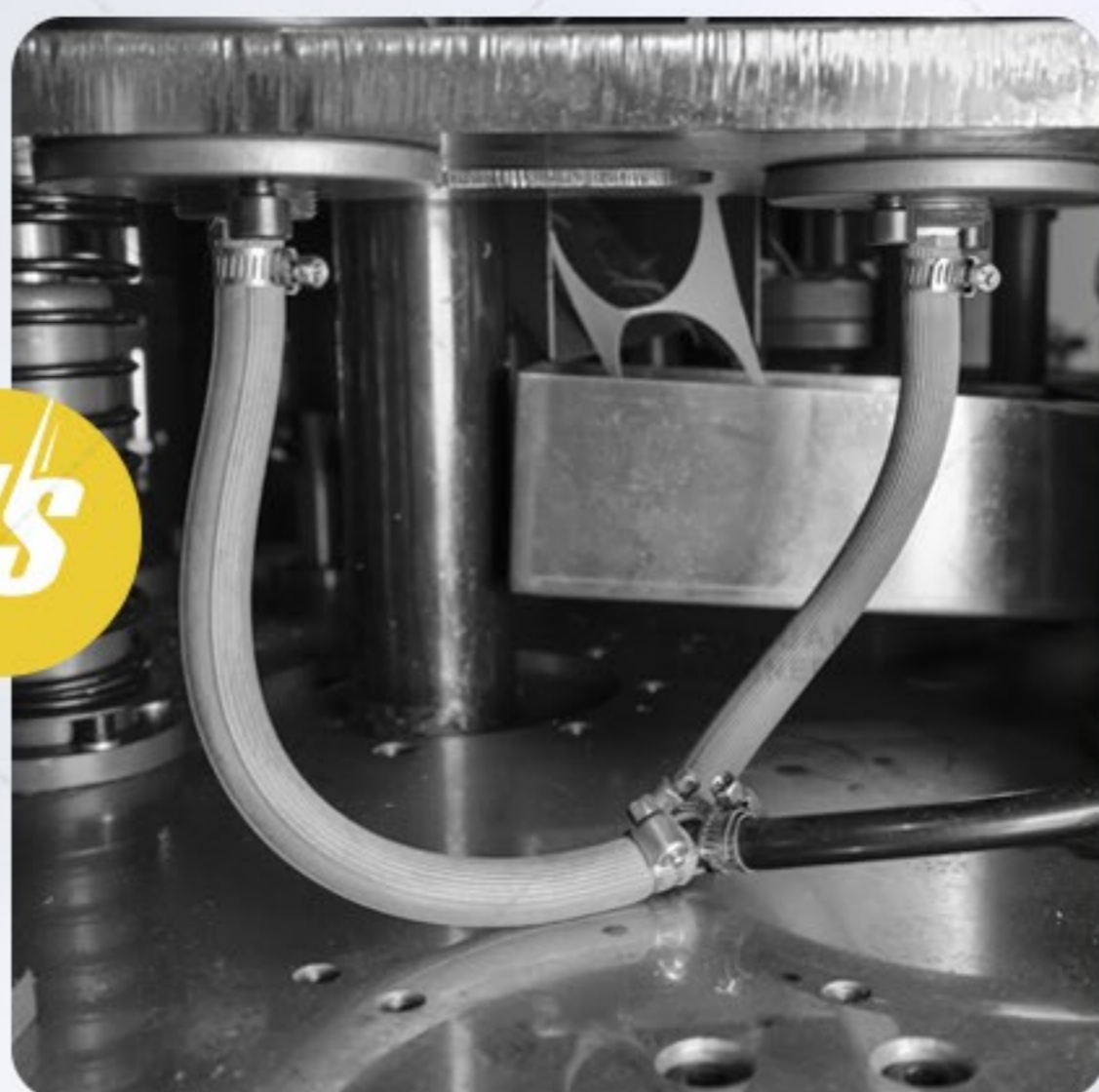

It is for the connection of hot air blowing heater , durable and high temperature resistance.

Plastic pipe is broken easily, and cause air leaking and cup bottom leakage issues.

12 PCS Honeywell Relay

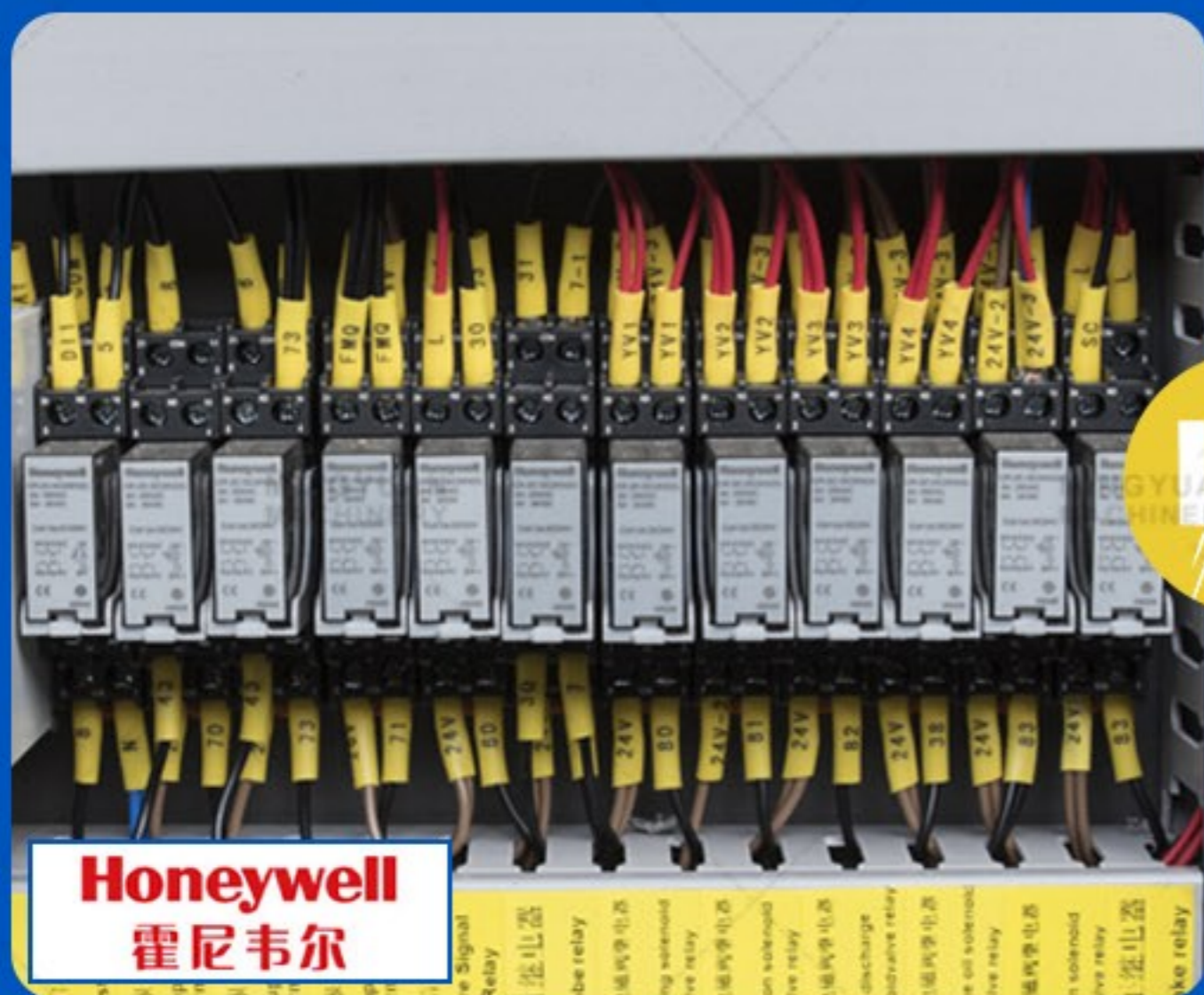

Other



Best Imported US brand relay , best quality and longer service life.

It is inferior brand and will be broken easily.(quality is not assured)

12 Pcs Of Sensor

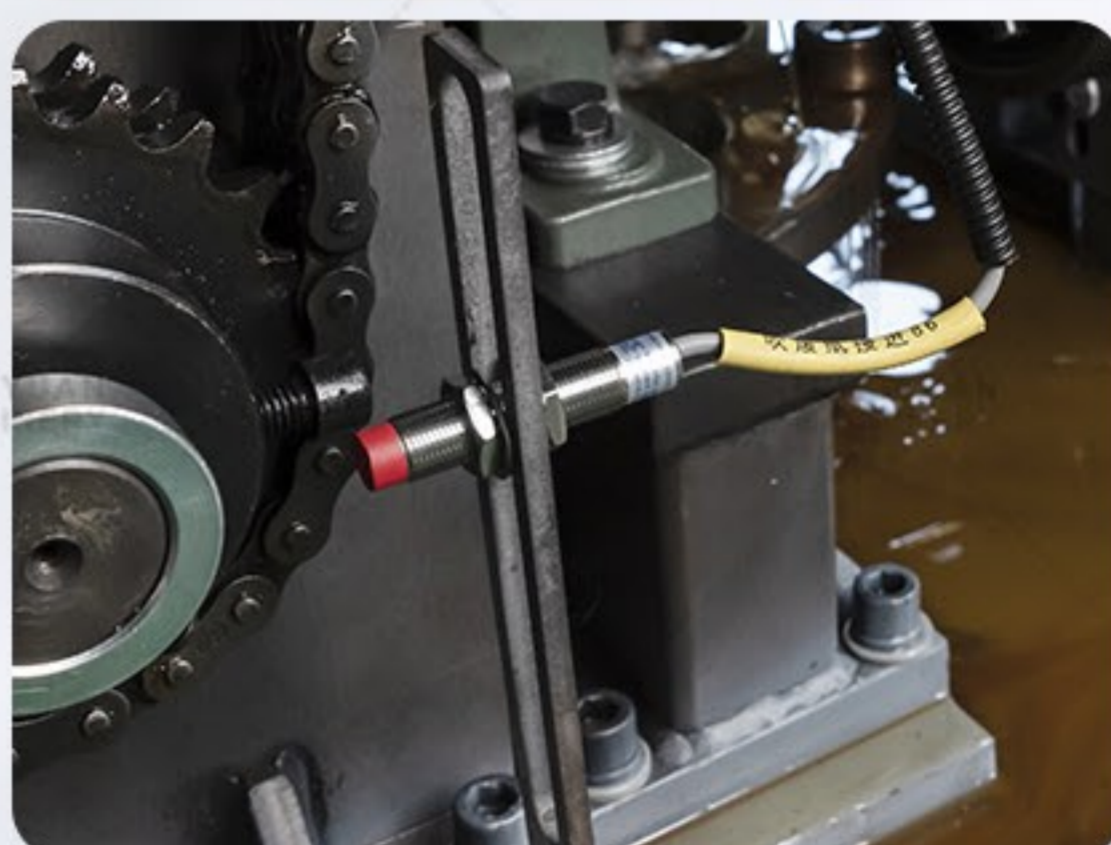
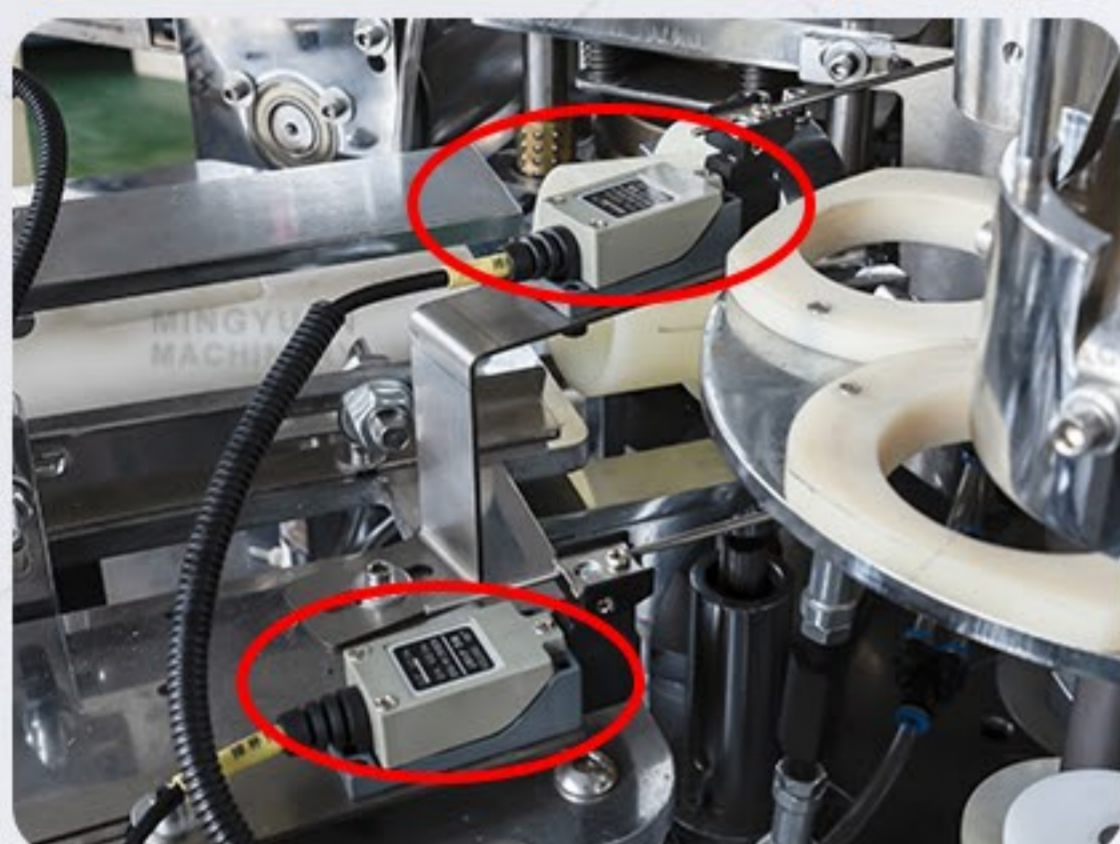
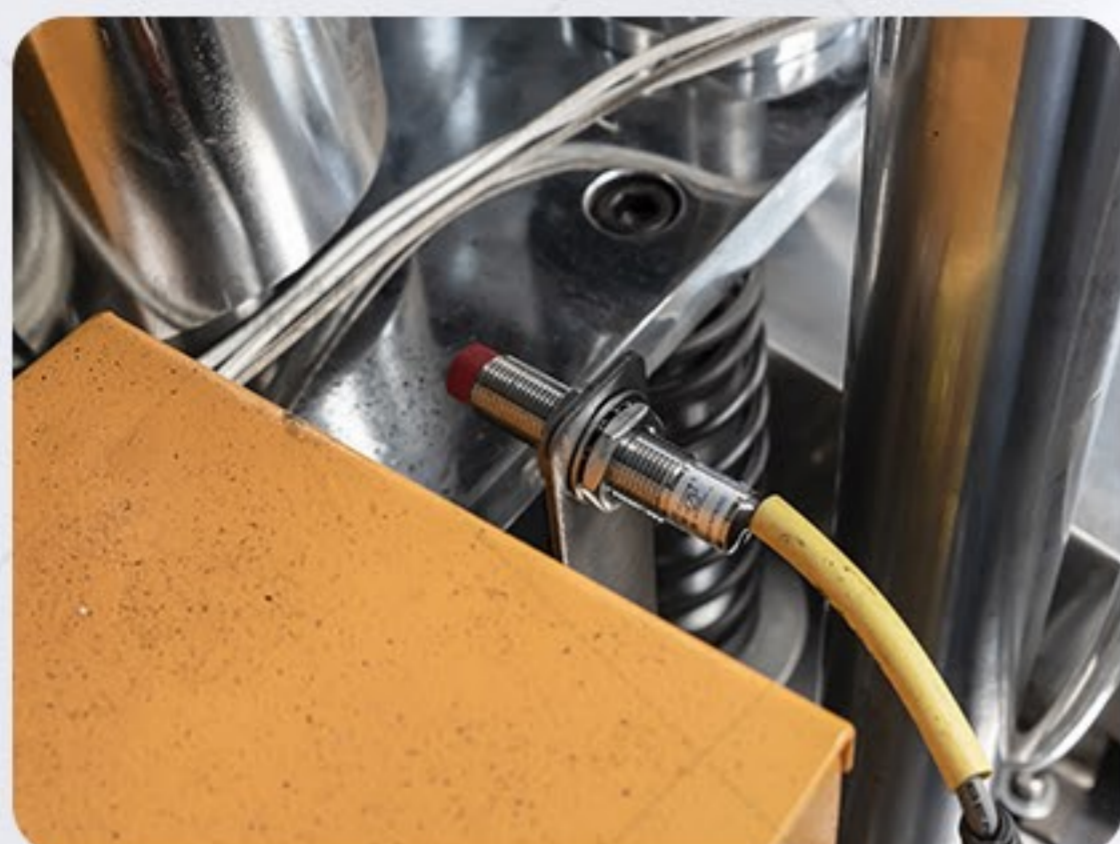
MINGYUAN
MACHINERYMINGYUAN
MACHINERY

12 PCS of sensor: It can detect the full working process of the machine like paper less ,paper stuck,paper tube blocking, hot air blowing,bottom paper feeding and cup passing by errors。 It will send alarm and ensure machine inside spare parts less collision issues,and run more stable.

Others: Less sensors only 6 pcs,machine running process will cause some issues and finished cups will be not good.

Oil Lubrication and Circulation

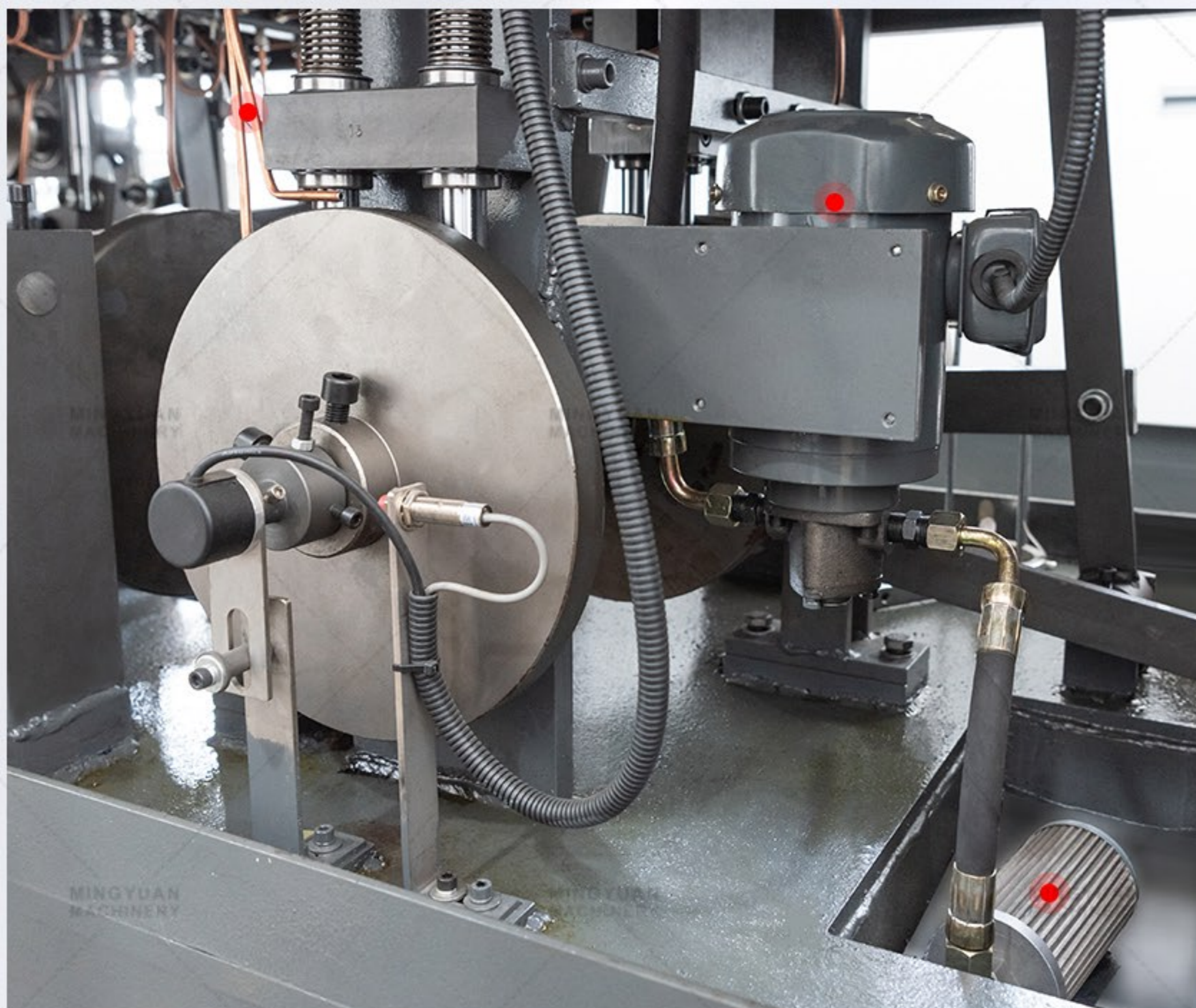
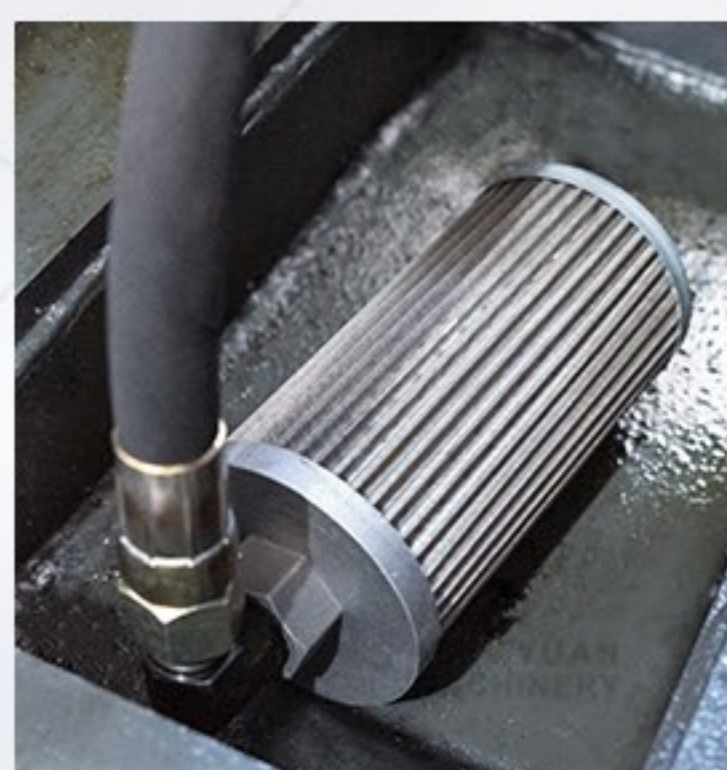
MINGYUAN
MACHINERYMINGYUAN
MACHINERYMINGYUAN
MACHINERYMINGYUAN
MACHINERY**COPPER PIPE****OIL MOTOR****FILTER**

The whole machine adopts automatic oil lubrication system (oil circulation system is including oil motor, filter, copper pipe) which makes all gear moving parts working at high speed much more smoothly and greatly Improve the service life of spare parts .









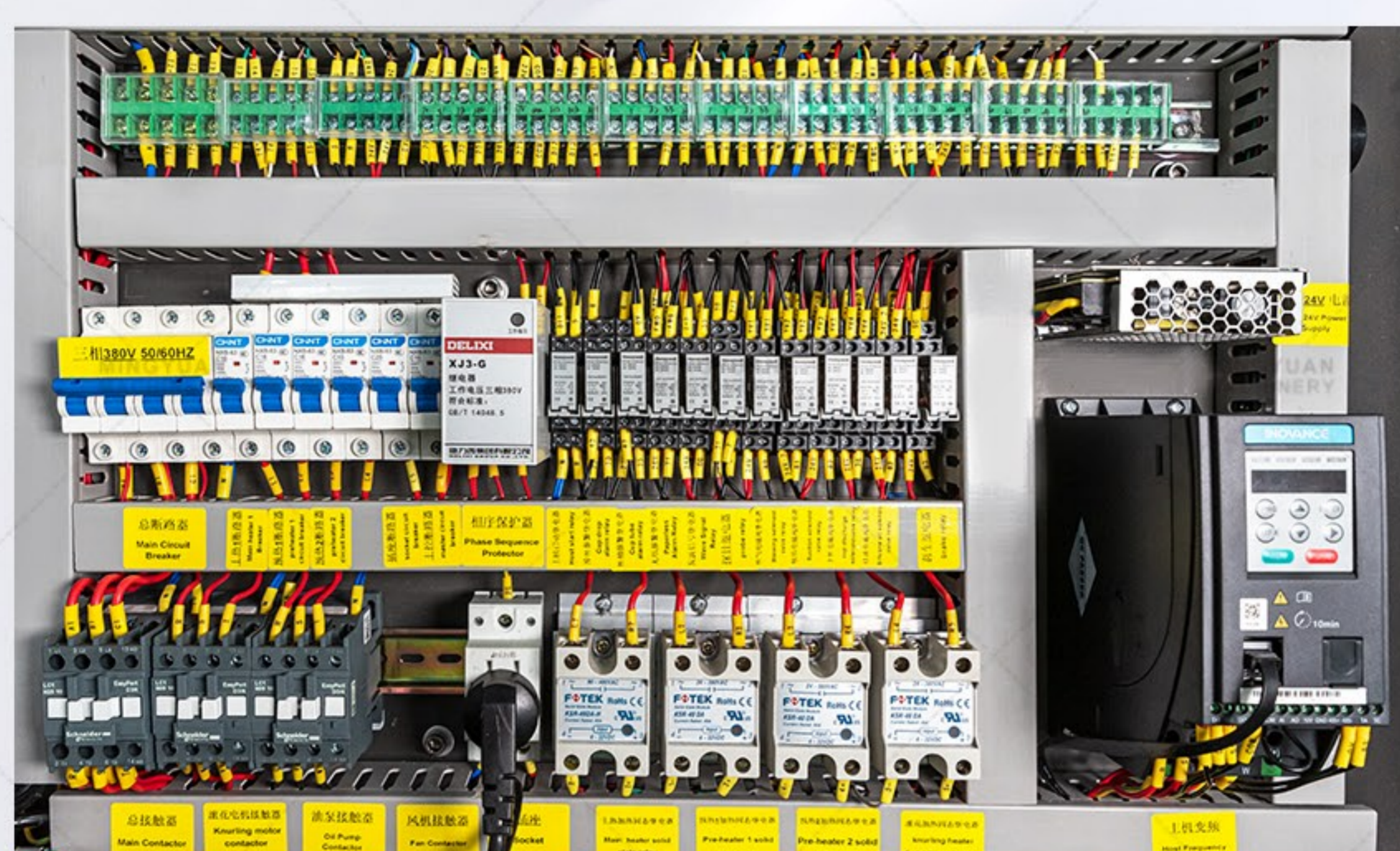













MINGYUAN
MACHINERYMINGYUAN
MACHINERYMINGYUAN
MACHINERY

Electric Components List



MINGYUAN MACHINERY



Brand	Picture	Name
 FRENCH BRAND		AC CONTACTOR 3 x PCS
 FRENCH BRAND		PUSH BUTTON & ROTARY SWITCH 18 x PCS
 AMERICAN BRAND		RELAY 12 x PCS
 JAPANESE BRAND		PHOTOELECTRICITY 3 x PCS
 TAIWAN BRAND		SWITCHING POWER SUPPLY 1 x PCS
 TAIWAN BRAND		SOLID STATE RELAY 4 x PCS
 CHINA DELIXI CHINESE BRAND		PHASE SEQUENCE PROTECTOR 1 x PCS
 CHINESE BRAND		CIRCUIT BREAKER 7 x PCS
 CHINESE BRAND		INVERTER 1 x PCS
 CHINESE BRAND		DIGITAL DISPLAY TIME RELAY 1 x PCS
 CHINESE BRAND		TEMPERATURE CONTROLLER 5 x PCS

Free Tool Box

MINGYUAN MACHINERY

MINGYUAN MACHINERY

MINGYUAN MACHINERY



X1

MINGYUAN MACHINERY

Nipper Pliers



X1

MINGYUAN MACHINERY

Inner Hexagonal Spanner



X1

MINGYUAN MACHINERY

Open-end Wrench



X1

MINGYUAN MACHINERY

Screwdriver (+ -)



X1

MINGYUAN MACHINERY

Box End Wrench



X1

MINGYUAN MACHINERY

Bearing



X1

MINGYUAN MACHINERY

Electrical Tape



X1

MINGYUAN MACHINERY

Hammer

MINGYUAN MACHINERY

MINGYUAN MACHINERY

MINGYUAN MACHINERY



Free Tool Box

MINGYUAN MACHINERY

MINGYUAN MACHINERY

MINGYUAN MACHINERY



X1



MINGYUAN MACHINERY

MINGYUAN MACHINERY

Adjustable Spanner

X1



MINGYUAN MACHINERY

Oil Gun

X1



Preheat Heating Collar

X1



Preheat Heating Collar

X4



MINGYUAN MACHINERY

MINGYUAN MACHINERY

Sucker

X2



MINGYUAN MACHINERY

Springs

X1



MINGYUAN MACHINERY

MINGYUAN MACHINERY

Screws

X1



MINGYUAN MACHINERY

Aluminium Heater

Good Service Win Client Trust



MINGYUAN MACHINERY

MINGYUAN MACHINERY

MINGYUAN MACHINERY

We will send the ultrasonic control box by DHL .

下午3:20 ✓✓

Hi Andy,
Thanks for listening.
In fact, you are fantastic. I will never change suppliers ...

Reliable Quality

MINGYUAN MACHINERY

MINGYUAN MACHINERY

MINGYUAN MACHINERY

Ok, you, your Company is so much cooperative. I always remember your company.

下午2:49

Excellent Service

Thank you. 下午2:50 ✓✓

Ok, Some one call me from Dhaka to know about machine. I tell him my experience.

下午3:02

MINGYUAN MACHINERY

MINGYUAN MACHINERY

MINGYUAN MACHINERY

de the production line will be fine we will buy you 5 more machines

07:55

Trustworthy

dont worry, we have more than 12years exprience in manufacture and export

07:56 ✓✓

MINGYUAN MACHINERY

MINGYUAN MACHINERY

MINGYUAN MACHINERY

It will be a pleasure collaborate with you company ASAP

下午4:21

Pleasure Cooperation

. It is nice to cooperate

下午4:22 ✓✓

MINGYUAN MACHINERY

MINGYUAN MACHINERY

MINGYUAN MACHINERY

Rest Assured To Buy



MINGYUAN MACHINERY

Warranty of spare parts

Spare Parts guarantee for two year since client received machine.



MINGYUAN MACHINERY

Technical engineer support

Send technician for installation & training, the cost cover by buyer (round ticket, accommodation, Salary of USD 100 Each day)



MINGYUAN MACHINERY

Operation manuals & online supports

We will provide the operation CD and manual, we also supply the 24 hours online service.



MINGYUAN MACHINERY

Bussiness support

We will offer the most professional suggestion to help you start and expand your business.



MINGYUAN MACHINERY

We are a company with solutions

AFTER-SALES VIDEO



MINGYUAN MACHINERY

MINGYUAN MACHINERY



MING MAC

Certificates



Certificate - Сертификат - 證明書 - Certificat - 증명서 - شهادة

Certificate of Compliance

No. 3B191223.RMMWU87
Test Report no. MY(19)12201-MD

Certificate's Holder: RUIAN MINGYUAN MACHINERY CO., LTD.
No. 388, Sunao Road, Feiyun Street, Ruian City, Zhejiang Province, China. Zip: 325207

Certification ECM Mark: 

Product: Paper Cup Machine
Model(s): JBZ-OCM12, JBZ-H12, JBZ-OCH12, JBZ-OCS9, JBZ-OCS12, JBZ-OCG16, JBZ-H16, JBZ-H22, JBZ-Bowl, JBZ-Bucket, JBZ-OC100

Verification to: Standard: EN ISO 12100:2010, EN 60204-1:2006+A1:2009+AC:2010
related to CE Directive(s): 2006/42/EC (Machinery)

Remark: the product(s) has been verified on a voluntary basis. The product(s) satisfies the requirements of the Certification Mark of ECM, in accordance to the above listed Standard(s). The above Compliance Mark can be affixed on the product(s) according to the ECM regulations about its release and its use. The regulation can be found at www.enfocema.it. This Certificate of Compliance can be checked for validity at www.enfocema.it (its verification doesn't imply assessment of the production of the product(s)).

Additional information, clarification about the CE Marking: We collect first to ICF for the CE Marking process is in place. Whereas the Manufacturer is Responsible to start the CE Marking Certification procedure and to perform all the necessary activities, as required by the Directive before placing the CE Mark on the product(s).

Date of issue 23 December 2019 Expiry date 23 December 2024

Chief Manager  *Deputy Manager* 

Ente Certificazione Macchine Srl
Via Ca' Bella, 243 - Loc. Castello di Senovalle - 40033 Valsamoggia (BO) - ITALY
+39 051 6705141 +39 051 6705156 info@enfocema.it www.enfocema.it

EUROPEAN COMMUNITY - CERTIFICATE OF ADEQUACY

CERTIFICATE NUMBER OVI/20160418A/Issue 1

Certificate Holder: RUIAN MINGYUAN MACHINERY CO.,LTD.
Henghe Industrial Park Feiyun Street Ruian City Zhejiang Province China

Manufacturer: RUIAN MINGYUAN MACHINERY CO.,LTD.
Henghe Industrial Park Feiyun Street Ruian City Zhejiang Province China

Technical Reference/Date: OVI TEST - MY - 2016-418A 18 nd April 2016

Type: Plastic Lid Thermoforming Machine

Model: HLD-450W, HLD-450WPP, DPP-420A, DPP-420G, DPP-420PP, DPP-420L, DPP-450W, DPP-450WPP.

Applicable EC Directives: Machinery Directive 2006/42/EC
Low Voltage Directive 2006/95/EC

Standards: EN ISO 12100:2010, EN 60204-1:2006+A1:2009+AC:2010

Based on our review we can confirm that the technical file for the above mentioned product meets the requirements of the relevant EC Directives.

The manufacturer is responsible for certifying the product and ensuring that all manufactured products are in compliance with the specifications detailed in the construction file.

CE Certificate issued: 18th April 2016
Signature: 

Shanghai OVI Information Technology Co., Ltd.
610 Yanhai International Building No.225 JinXing Road, Shanghai, P.R.China.
Tel: 86-21-51978253 FAX: 86-21-51978251

Alibaba.com Gold Plus Supplier

Verified

Assessment Report

Presented to
Ruian Mingyuan Machinery Co., Ltd.
瑞安市明源机械有限公司

Gold Supplier & Assessed Company Relationship:	<input checked="" type="checkbox"/> Self-owned <input type="checkbox"/> Wholly Owned <input type="checkbox"/> Shareholder/Partner <input type="checkbox"/> Kindred between Owners <input type="checkbox"/> Cooperation Partner
Company Address:	No. 658, Sunhe Road, Feiyun Street, Ruian, Wenzhou City, Zhejiang Province, China
City / Country:	Wenzhou / China
Consigner of Assessment:	Alibaba
Gold Supplier Member ID:	mingyuanmachinery
Gold Supplier Company Name:	Ruian Mingyuan Machinery Co., Ltd.
Contact Person:	Mr. Wanjin Chi
Phone Number:	0086-15157799231
Fax Number:	Confidential
Email:	mingyuanmachine@gmail.com
Website Address (URL):	http://mingyuanmachinery.en.alibaba.com

Service Provided by SGS
Report No.: 21661751_P+T

证书号第 6517449 号



实用新型专利证书

实用新型名称: 用于超声波纸杯机的传送机构

发 明 人: 池万满

专 利 号: ZL 2017 2 0202265.9

专利申请日: 2017年03月03日

专 利 权 人: 瑞安市明源机械有限公司

授权公告日: 2017年10月03日

本实用新型经过本局依照中华人民共和国专利法进行初步审查, 决定授予专利权, 颁发本证书并在专利登记簿上予以登记, 专利权自授权公告之日起生效。
本专利的专利权期限为十年, 自申请日起算, 专利权人应当依照专利法及其实施细则规定缴纳年费, 本专利的年费应当在每年03月03日前缴纳, 未按照规定缴纳年费的, 专利权自应当缴纳年费期满之日起终止。
专利证书记载专利权登记时的法律状况, 专利权的转移、质押、无效、终止、恢复和专利权人的姓名或名称、国籍、地址变更等事项记载在专利登记簿上。

局长 
申长雨

2017年10月03日

Company View Image



Other Machine



MINGYUAN MACHINERY

MINGYUAN MACHINERY

MINGYUAN MACHINERY

Intelligence Paper Cup Machine



High Speed Paper Lid Machine



Hydraulic Paper Plate Machine



Intelligence Paper Bowl Machine



Paper Cup Sleeve Machine



Intelligence Paper Bucket Machine

